

< IGBT MODULES >

CM200EXS-34SA

HIGH POWER SWITCHING USE
INSULATED TYPE

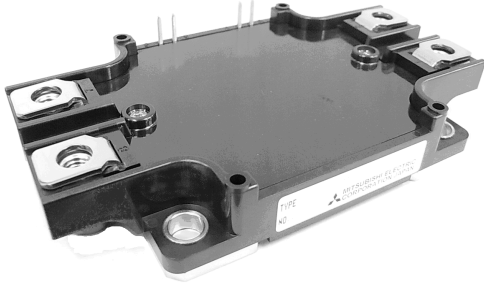

Single switch

Collector current I_C 200 A
 Collector-emitter voltage V_{CES} 1700 V
 Maximum junction temperature T_{jmax} 175 °C

- Flat base Type
- Copper base plate (non-plating)
- Tin plating pin terminals
- RoHS Directive compliance
- Recognized under UL1557, File E323585

APPLICATION

Brake

OUTLINE DRAWING & INTERNAL CONNECTION

Dimension in mm

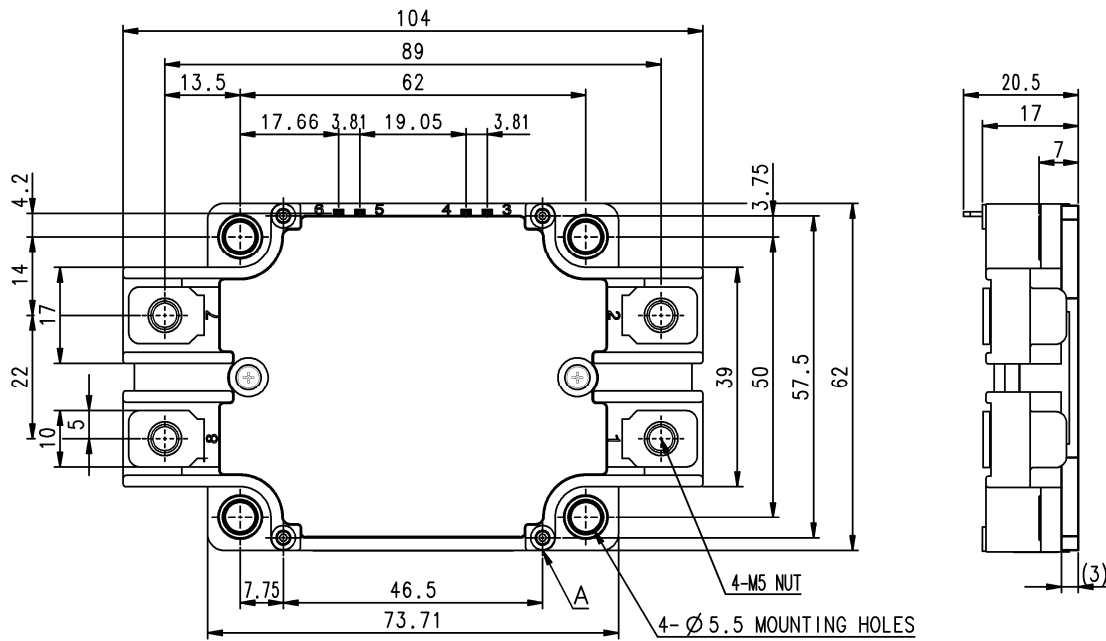

TERMINAL

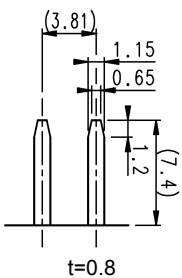

SECTION A

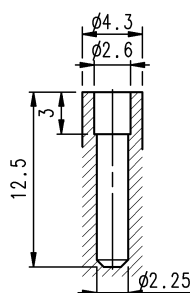

Tolerance otherwise specified

Division of Dimension	Tolerance
0.5 to 3	±0.2
over 3 to 6	±0.3
over 6 to 30	±0.5
over 30 to 120	±0.8
over 120 to 400	±1.2

The tolerance of size between terminals is assumed to be ±0.4.

INTERNAL CONNECTION

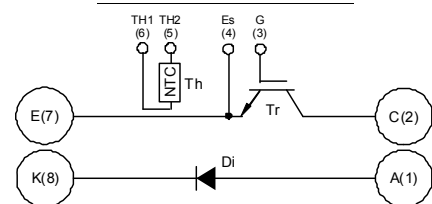

< IGBT MODULES >

CM200EXS-34SA

HIGH POWER SWITCHING USE
INSULATED TYPE

MAXIMUM RATINGS ($T_j=25\text{ }^\circ\text{C}$, unless otherwise specified)

IGBT

Symbol	Item	Conditions	Rating	Unit
V_{CES}	Collector-emitter voltage	G-E short-circuited	1700	V
V_{GES}	Gate-emitter voltage	C-E short-circuited	± 20	V
I_C	Collector current	DC, $T_C=125\text{ }^\circ\text{C}$ (Note1, 3)	200	A
I_{CRM}		Pulse, Repetitive (Note2)	400	
P_{tot}	Total power dissipation	$T_C=25\text{ }^\circ\text{C}$ (Note1, 3)	2000	W

DIODE

Symbol	Item	Conditions	Rating	Unit
V_{RRM}	Repetitive peak reverse voltage	-	1700	V
I_F	Forward current	DC (Note1)	200	A
I_{FRM}		Pulse, Repetitive (Note2)	400	

MODULE

Symbol	Item	Conditions	Rating	Unit
V_{isol}	Isolation voltage	Terminals to base plate, RMS, $f=60\text{ Hz}$, AC 1 min	4000	V
T_{jmax}	Maximum junction temperature	Instantaneous event (overload)	175	$^\circ\text{C}$
T_{Cmax}	Maximum case temperature	(Note3)	125	
T_{jop}	Operating junction temperature	Continuous operation (under switching)	-40 ~ +150	$^\circ\text{C}$
T_{stg}	Storage temperature	-	-40 ~ +125	

ELECTRICAL CHARACTERISTICS ($T_j=25\text{ }^\circ\text{C}$, unless otherwise specified)

IGBT

Symbol	Item	Conditions	Limits			Unit	
			Min.	Typ.	Max.		
I_{CES}	Collector-emitter cut-off current	$V_{CE}=V_{CES}$, G-E short-circuited	-	-	1.0	mA	
I_{GES}	Gate-emitter leakage current	$V_{GE}=V_{GES}$, C-E short-circuited	-	-	0.5	μA	
$V_{GE(th)}$	Gate-emitter threshold voltage	$I_C=20\text{ mA}$, $V_{CE}=10\text{ V}$	5.4	6.0	6.6	V	
V_{Cesat} (Terminal)	Collector-emitter saturation voltage	$I_C=200\text{ A}$, $V_{GE}=15\text{ V}$, Refer to the figure of test circuit. (Note6)	$T_j=25\text{ }^\circ\text{C}$	-	2.00	2.50	V
			$T_j=125\text{ }^\circ\text{C}$	-	2.20	-	
			$T_j=150\text{ }^\circ\text{C}$	-	2.25	-	
V_{Cesat} (Chip)		$I_C=200\text{ A}$, $V_{GE}=15\text{ V}$, (Note6)	$T_j=25\text{ }^\circ\text{C}$	-	1.90	2.40	V
			$T_j=125\text{ }^\circ\text{C}$	-	2.10	-	
			$T_j=150\text{ }^\circ\text{C}$	-	2.15	-	
C_{ies}	Input capacitance	$V_{CE}=10\text{ V}$, G-E short-circuited	-	-	53	nF	
C_{oes}	Output capacitance		-	-	4.3		
C_{res}	Reverse transfer capacitance		-	-	0.97		
Q_G	Gate charge	$V_{CC}=1000\text{ V}$, $I_C=200\text{ A}$, $V_{GE}=15\text{ V}$	-	1100	-	nC	
$t_{d(on)}$	Turn-on delay time	$V_{CC}=1000\text{ V}$, $I_C=200\text{ A}$, $V_{GE}=\pm 15\text{ V}$, $R_G=0\text{ }\Omega$, Inductive load	-	-	400	ns	
t_r	Rise time		-	-	100		
$t_{d(off)}$	Turn-off delay time		-	-	700		
t_f	Fall time		-	-	600		
E_{on}	Turn-on switching energy per pulse	$V_{CC}=1000\text{ V}$, $I_C=I_E=200\text{ A}$, $V_{GE}=\pm 15\text{ V}$, $R_G=0\text{ }\Omega$, $T_j=150\text{ }^\circ\text{C}$, Inductive load	-	28	-	mJ	
E_{off}	Turn-off switching energy per pulse		-	52	-		
$R_{CC+EE'}$	Internal lead resistance	Main terminals-chip, per element, $T_C=25\text{ }^\circ\text{C}$ (Note3)	-	-	2.0	m Ω	
r_g	Internal gate resistance	-	-	2.5	-	Ω	

< IGBT MODULES >

CM200EXS-34SA

HIGH POWER SWITCHING USE
INSULATED TYPE

ELECTRICAL CHARACTERISTICS (cont; T_j=25 °C, unless otherwise specified)

DIODE PART

Symbol	Item	Conditions	Limits			Unit	
			Min.	Typ.	Max.		
I _{RRM}	Reverse current	V _R =V _{RRM}	-	-	1.0	mA	
V _F (Terminal)	Forward voltage	I _F =200 A, Refer to the figure of test circuit. (Note6)	T _j =25 °C	-	4.1	5.3	V
			T _j =125 °C	-	2.9	-	
			T _j =150 °C	-	2.7	-	
V _F (Chip)	Forward voltage	I _F =200 A, (Note6)	T _j =25 °C	-	4.0	5.2	V
			T _j =125 °C	-	2.8	-	
			T _j =150 °C	-	2.6	-	
t _{rr}	Reverse recovery time	V _{CC} =1000 V, I _F =200 A, V _{GE} =±15 V,	-	-	300	ns	
Q _{rr}	Reverse recovery charge	R _G =0 Ω, Inductive load	-	8.0	-	μC	
E _{rr}	Reverse recovery energy per pulse	V _{CC} =1000 V, I _F =200 A, V _{GE} =±15 V, R _G =0 Ω, T _j =150 °C, Inductive load	-	42	-	mJ	

NTC THERMISTOR PART

Symbol	Item	Conditions	Limits			Unit
			Min.	Typ.	Max.	
R ₂₅	Zero-power resistance	T _C =25 °C (Note3)	4.85	5.00	5.15	kΩ
ΔR/R	Deviation of resistance	R ₁₀₀ =493 Ω, T _C =100 °C (Note3)	-7.3	-	+7.8	%
B _(25/50)	B-constant	Approximate by equation (Note5)	-	3375	-	K
P ₂₅	Power dissipation	T _C =25 °C (Note3)	-	-	10	mW

THERMAL RESISTANCE CHARACTERISTICS

Symbol	Item	Conditions	Limits			Unit
			Min.	Typ.	Max.	
R _{th(j-c)Q}	Thermal resistance	Junction to case, IGBT (Note3)	-	-	0.075	K/W
R _{th(j-c)D}		Junction to case, DIODE (Note3)	-	-	0.12	
R _{th(c-s)}	Contact thermal resistance	Case to heat sink, per 1 module, Thermal grease applied (Note3, 6)	-	25	-	K/kW

MECHANICAL CHARACTERISTICS

Symbol	Item	Conditions	Limits			Unit
			Min.	Typ.	Max.	
M _t	Mounting torque	Main terminals M 5 screw	2.5	3.0	3.5	N·m
M _s	Mounting torque	Mounting to heat sink M 5 screw	2.5	3.0	3.5	
d _s	Creepage distance	Terminal to terminal	20.6	-	-	mm
		Terminal to base plate	17	-	-	
d _a	Clearance	Terminal to terminal	12	-	-	mm
		Terminal to base plate	10.6	-	-	
m	mass	-	-	210	-	g
e _c	Flatness of base plate	On the centerline X, Y (Note7)	-100	-	+100	μm

< IGBT MODULES >
CM200EXS-34SA
HIGH POWER SWITCHING USE
INSULATED TYPE

- Note1. Junction temperature (T_j) should not increase beyond T_{jmax} rating.
 2. Pulse width and repetition rate should be such that the device junction temperature (T_j) dose not exceed T_{jmax} rating.
 3. Case temperature (T_c) and heat sink temperature (T_s) are defined on the each surface (mounting side) of base plate and heat sink just under the chips. Refer to the figure of chip location.
 4. Pulse width and repetition rate should be such as to cause negligible temperature rise.
 5. $B_{(25/50)} = \ln\left(\frac{R_{25}}{R_{50}}\right) / \left(\frac{1}{T_{25}} - \frac{1}{T_{50}}\right)$,
 R_{25} : resistance at absolute temperature T_{25} [K]; $T_{25}=25 [^{\circ}\text{C}]+273.15=298.15$ [K]
 R_{50} : resistance at absolute temperature T_{50} [K]; $T_{50}=50 [^{\circ}\text{C}]+273.15=323.15$ [K]
 6. Typical value is measured by using thermally conductive grease of $\lambda=0.9$ W/(m·K).
 7. The base plate (mounting side) flatness measurement points (X, Y) are as follows of the following figure.

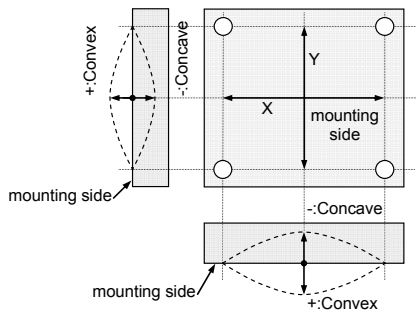

8. Use the following screws when mounting the printed circuit board (PCB) on the stand offs.
 "φ2.6×10 or φ2.6×12 self tapping screw"
 The length of the screw depends on thickness (t1.6~t2.0) of the PCB.

RECOMMENDED OPERATING CONDITIONS

Symbol	Item	Conditions	Limits			Unit
			Min.	Typ.	Max.	
V_{CC}	(DC) Supply voltage	Applied across C-E/A-K	-	1000	1200	V
V_{GEon}	Gate (-emitter drive) voltage	Applied across G-Es	13.5	15.0	16.5	V
R_G	External gate resistance	-	0	-	38	Ω

CHIP LOCATION (Top view)

Dimension in mm, tolerance: ±1 mm

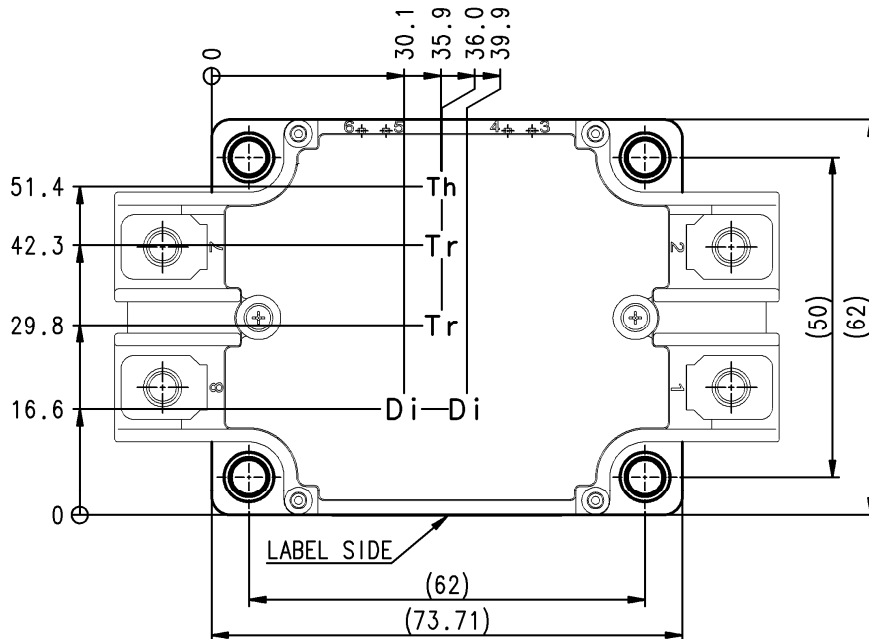

Tr: IGBT, Di: DIODE, Th: NTC thermistor

< IGBT MODULES >
CM200EXS-34SA
 HIGH POWER SWITCHING USE
 INSULATED TYPE

TEST CIRCUIT AND WAVEFORMS

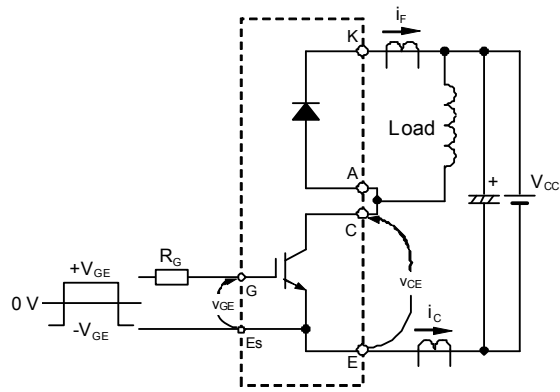

Switching characteristics test circuit and waveforms

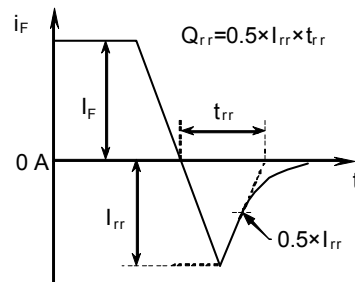
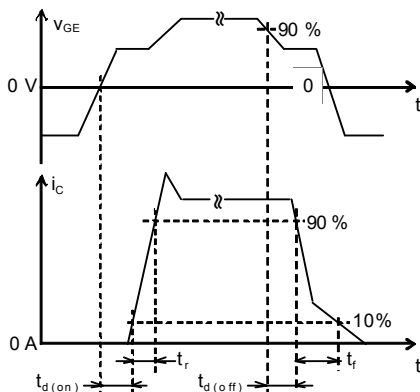

t_{rr} , Q_{rr} test waveform

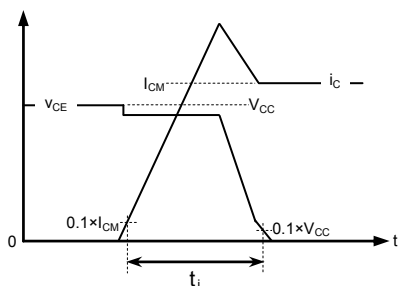

IGBT Turn-on switching energy

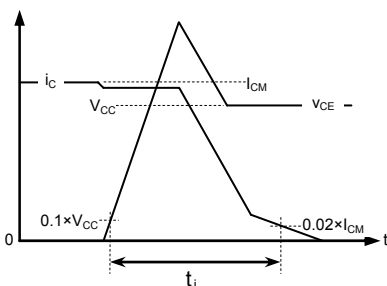

IGBT Turn-off switching energy

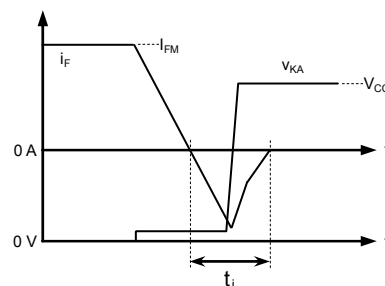

DIODE Reverse recovery energy

Turn-on / Turn-off switching energy and Reverse recovery energy test waveforms (Integral time instruction drawing)

TEST CIRCUIT

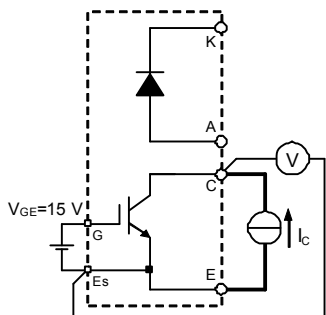

V_{CEsat} test circuit

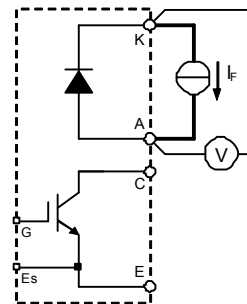

V_F test circuit

< IGBT MODULES >
CM200EXS-34SA
 HIGH POWER SWITCHING USE
 INSULATED TYPE

PERFORMANCE CURVES

IGBT/DIODE

OUTPUT CHARACTERISTICS
 (TYPICAL)

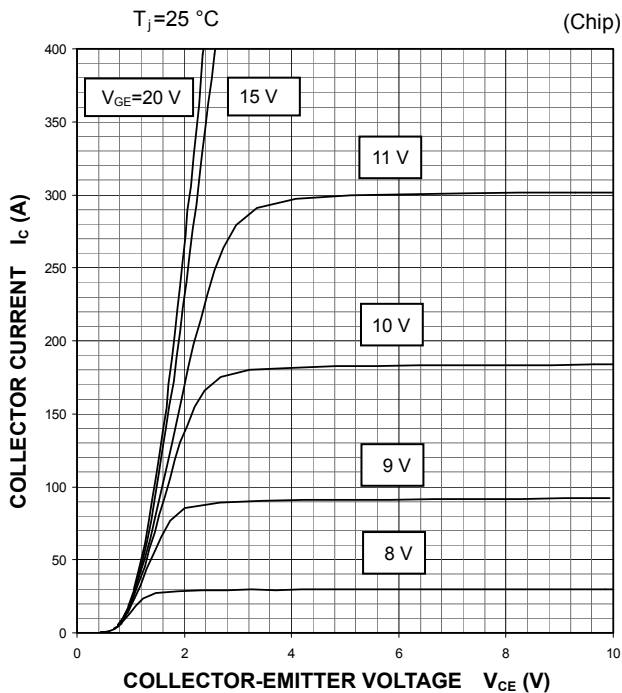

COLLECTOR-EMITTER SATURATION VOLTAGE
 CHARACTERISTICS
 (TYPICAL)

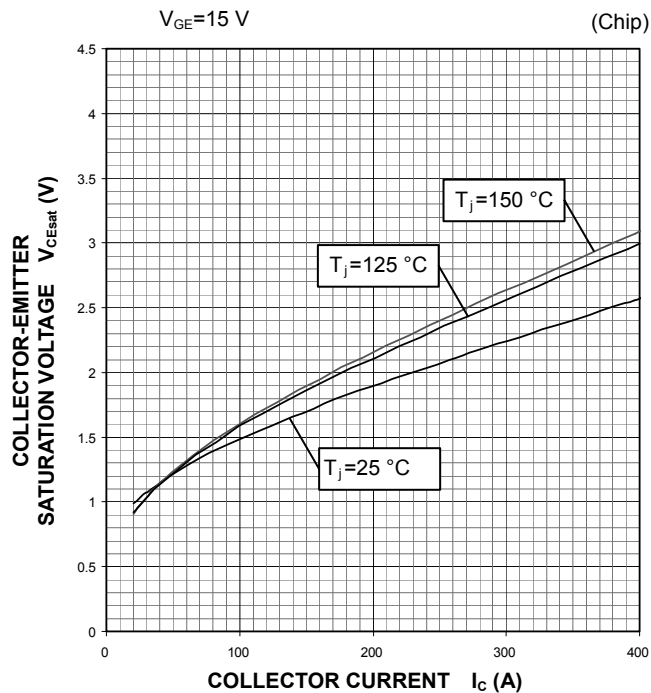

DIODE
 FORWARD CHARACTERISTICS
 (TYPICAL)

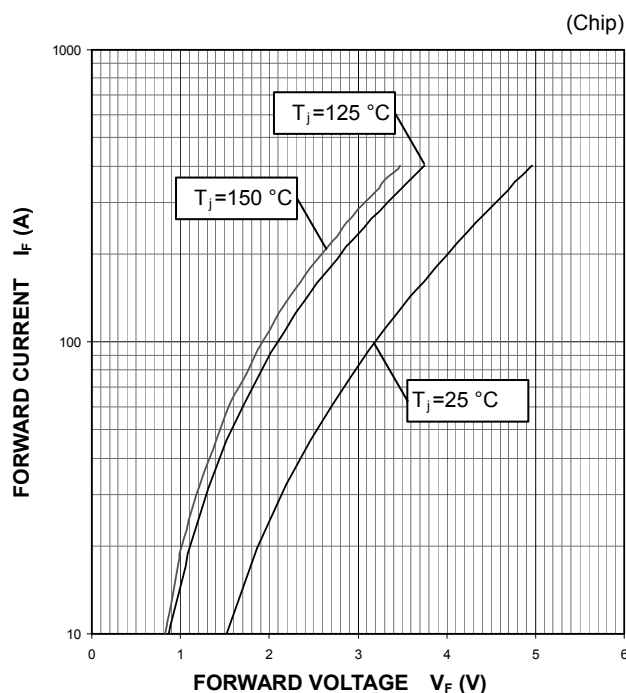

< IGBT MODULES >
CM200EXS-34SA
 HIGH POWER SWITCHING USE
 INSULATED TYPE

PERFORMANCE CURVES

IGBT/DIODE

HALF-BRIDGE
 SWITCHING CHARACTERISTICS
 (TYPICAL)

$V_{CC}=1000\text{ V}$, $V_{GE}=\pm 15\text{ V}$, $R_G=0\ \Omega$, INDUCTIVE LOAD
 —: $T_J=150\text{ }^\circ\text{C}$, - - - -: $T_J=125\text{ }^\circ\text{C}$

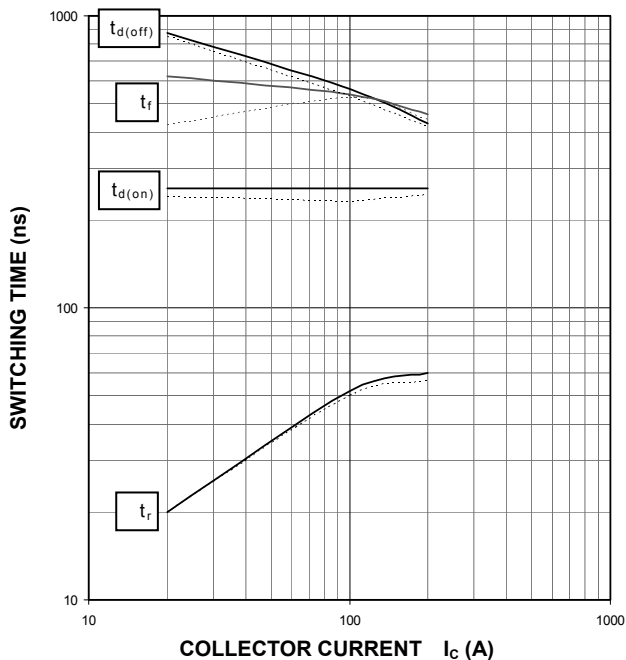

HALF-BRIDGE
 SWITCHING CHARACTERISTICS
 (TYPICAL)

$V_{CC}=1000\text{ V}$, $V_{GE}=\pm 15\text{ V}$, $I_C=200\text{ A}$, INDUCTIVE LOAD
 —: $T_J=150\text{ }^\circ\text{C}$, - - - -: $T_J=125\text{ }^\circ\text{C}$

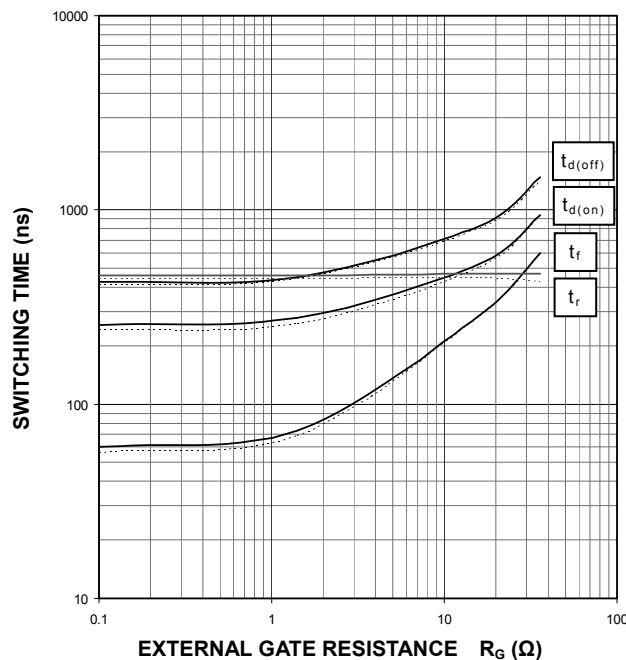

HALF-BRIDGE
 SWITCHING CHARACTERISTICS
 (TYPICAL)

$V_{CC}=1000\text{ V}$, $V_{GE}=\pm 15\text{ V}$, $R_G=0\ \Omega$,
 INDUCTIVE LOAD, PER PULSE
 —: $T_J=150\text{ }^\circ\text{C}$, - - - -: $T_J=125\text{ }^\circ\text{C}$

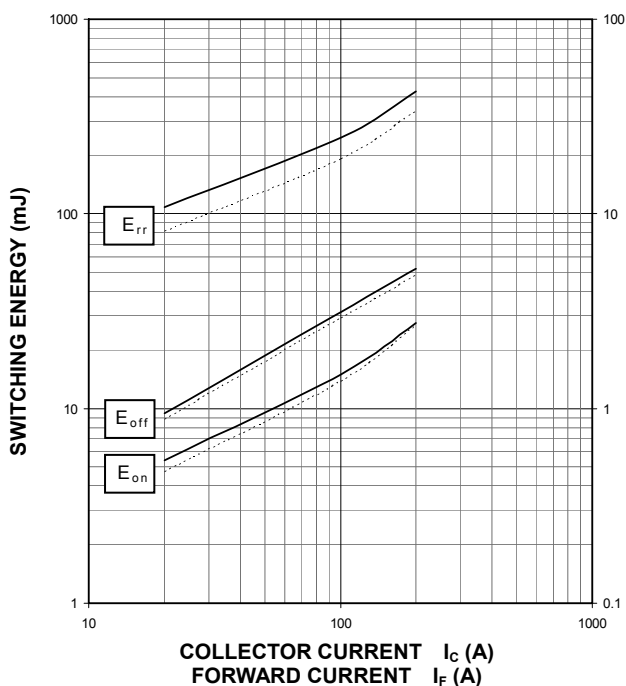

HALF-BRIDGE
 SWITCHING CHARACTERISTICS
 (TYPICAL)

$V_{CC}=1000\text{ V}$, $V_{GE}=\pm 15\text{ V}$, $I_C/I_F=200\text{ A}$,
 INDUCTIVE LOAD, PER PULSE
 —: $T_J=150\text{ }^\circ\text{C}$, - - - -: $T_J=125\text{ }^\circ\text{C}$

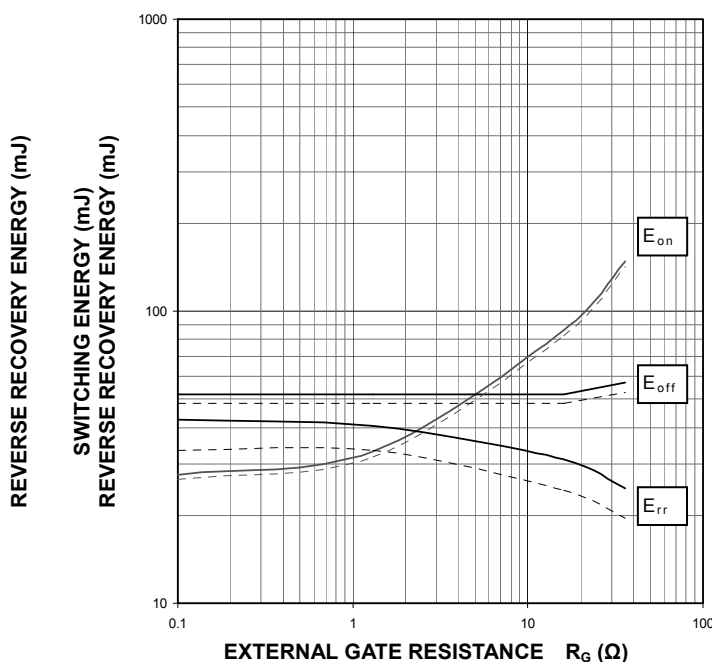

< IGBT MODULES >
CM200EXS-34SA
 HIGH POWER SWITCHING USE
 INSULATED TYPE

PERFORMANCE CURVES

IGBT/DIODE

CAPACITANCE CHARACTERISTICS
 (TYPICAL)

G-E short-circuited, $T_j=25\text{ }^\circ\text{C}$

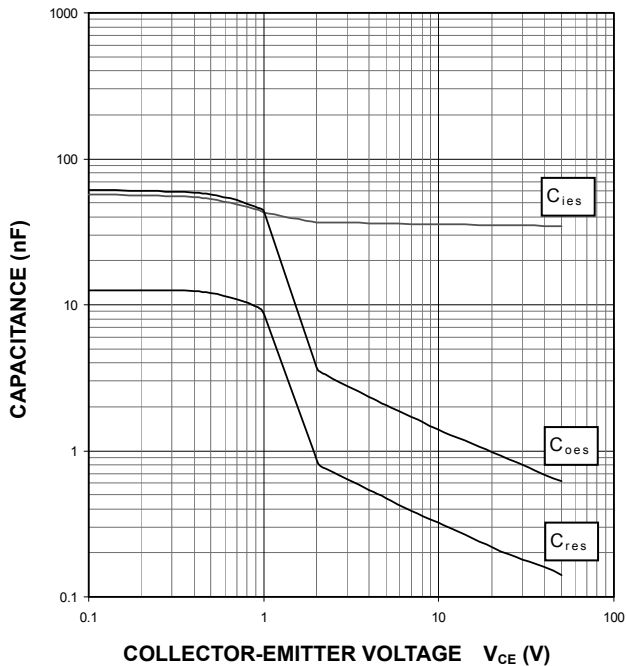

DIODE
REVERSE RECOVERY CHARACTERISTICS
 (TYPICAL)

$V_{CC}=1000\text{ V}$, $V_{GE}=\pm 15\text{ V}$, $R_G=0\ \Omega$, INDUCTIVE LOAD
 —: $T_j=150\text{ }^\circ\text{C}$, - - - -: $T_j=125\text{ }^\circ\text{C}$

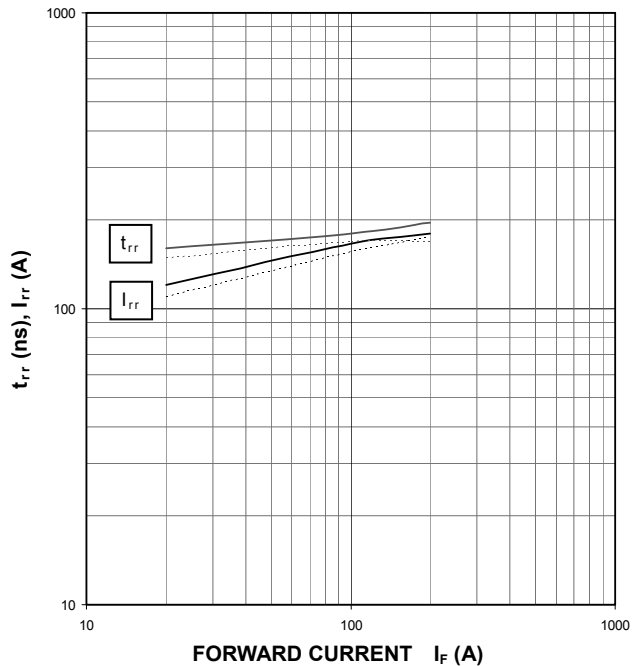

GATE CHARGE CHARACTERISTICS
 (TYPICAL)

$V_{CC}=1000\text{ V}$, $I_C=200\text{ A}$, $T_j=25\text{ }^\circ\text{C}$

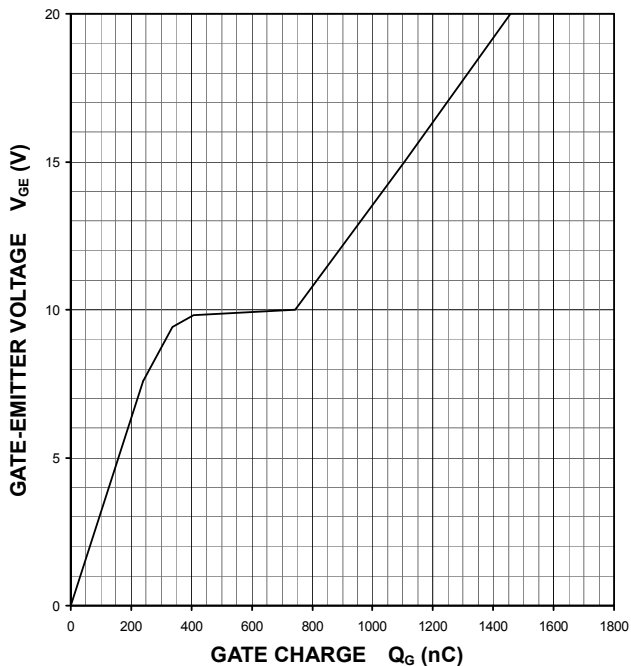

TRANSIENT THERMAL IMPEDANCE CHARACTERISTICS
 (MAXIMUM)

Single pulse, $T_C=25\text{ }^\circ\text{C}$
 $R_{th(j-c)Q}=0.075\text{ K/W}$, $R_{th(j-c)D}=0.12\text{ K/W}$

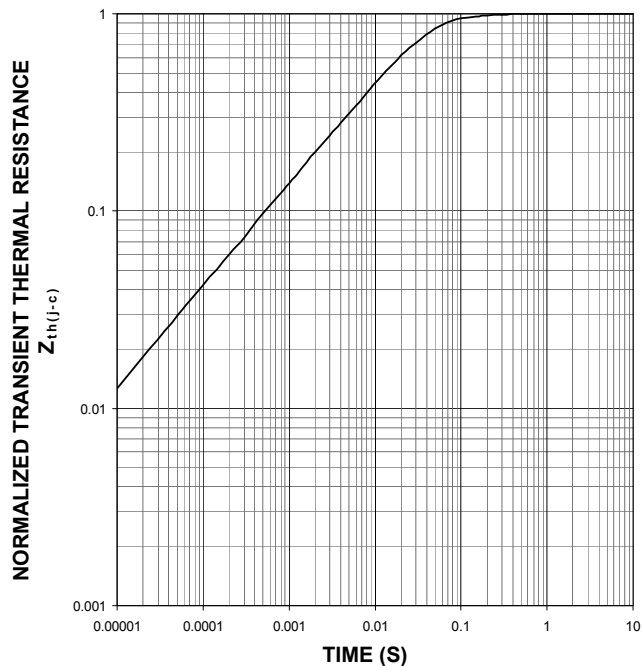

< IGBT MODULES >
CM200EXS-34SA
HIGH POWER SWITCHING USE
INSULATED TYPE

PERFORMANCE CURVES

NTC THERMISTOR

TEMPERATURE CHARACTERISTICS
(TYPICAL)

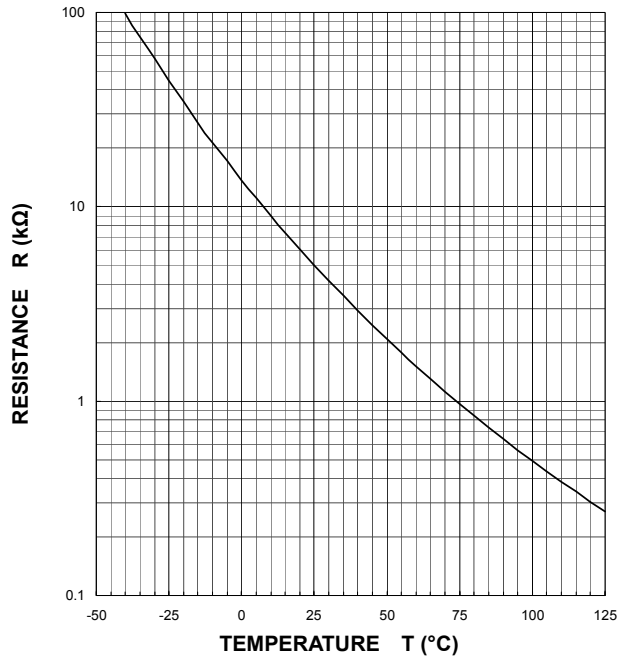

Keep safety first in your circuit designs!

Mitsubishi Electric Corporation puts the maximum effort into making semiconductor products better and more reliable, but there is always the possibility that trouble may occur with them. Trouble with semiconductors may lead to personal injury, fire or property damage. Remember to give due consideration to safety when making your circuit designs, with appropriate measures such as (i) placement of substitutive, auxiliary circuits, (ii) use of non-flammable material or (iii) prevention against any malfunction or mishap.

Notes regarding these materials

- These materials are intended as a reference to assist our customers in the selection of the Mitsubishi semiconductor product best suited to the customer's application; they do not convey any license under any intellectual property rights, or any other rights, belonging to Mitsubishi Electric Corporation or a third party.
- Mitsubishi Electric Corporation assumes no responsibility for any damage, or infringement of any third-party's rights, originating in the use of any product data, diagrams, charts, programs, algorithms, or circuit application examples contained in these materials.
- All information contained in these materials, including product data, diagrams, charts, programs and algorithms represents information on products at the time of publication of these materials, and are subject to change by Mitsubishi Electric Corporation without notice due to product improvements or other reasons. It is therefore recommended that customers contact Mitsubishi Electric Corporation or an authorized Mitsubishi Semiconductor product distributor for the latest product information before purchasing a product listed herein.
The information described here may contain technical inaccuracies or typographical errors. Mitsubishi Electric Corporation assumes no responsibility for any damage, liability, or other loss rising from these inaccuracies or errors.
Please also pay attention to information published by Mitsubishi Electric Corporation by various means, including the Mitsubishi Semiconductor home page (www.MitsubishiElectric.com/semiconductors/).
- When using any or all of the information contained in these materials, including product data, diagrams, charts, programs, and algorithms, please be sure to evaluate all information as a total system before making a final decision on the applicability of the information and products. Mitsubishi Electric Corporation assumes no responsibility for any damage, liability or other loss resulting from the information contained herein.
- Mitsubishi Electric Corporation semiconductors are not designed or manufactured for use in a device or system that is used under circumstances in which human life is potentially at stake. Please contact Mitsubishi Electric Corporation or an authorized Mitsubishi Semiconductor product distributor when considering the use of a product contained herein for any specific purposes, such as apparatus or systems for transportation, vehicular, medical, aerospace, nuclear, or undersea repeater use.
- The prior written approval of Mitsubishi Electric Corporation is necessary to reprint or reproduce in whole or in part these materials.
- If these products or technologies are subject to the Japanese export control restrictions, they must be exported under a license from the Japanese government and cannot be imported into a country other than the approved destination.
Any diversion or reexport contrary to the export control laws and regulations of Japan and/or the country of destination is prohibited.
- Please contact Mitsubishi Electric Corporation or an authorized Mitsubishi Semiconductor product distributor for further details on these materials or the products contained therein.