

MITSUBISHI IGBT MODULES  
**CM200TU-12F**

HIGH POWER SWITCHING USE

**CM200TU-12F**



- IC .....200A
- VCES .....600V
- Insulated Type
- 6-elements in a pack

**APPLICATION**

General purpose inverters & Servo controls, etc

**OUTLINE DRAWING & CIRCUIT DIAGRAM**

Dimensions in mm

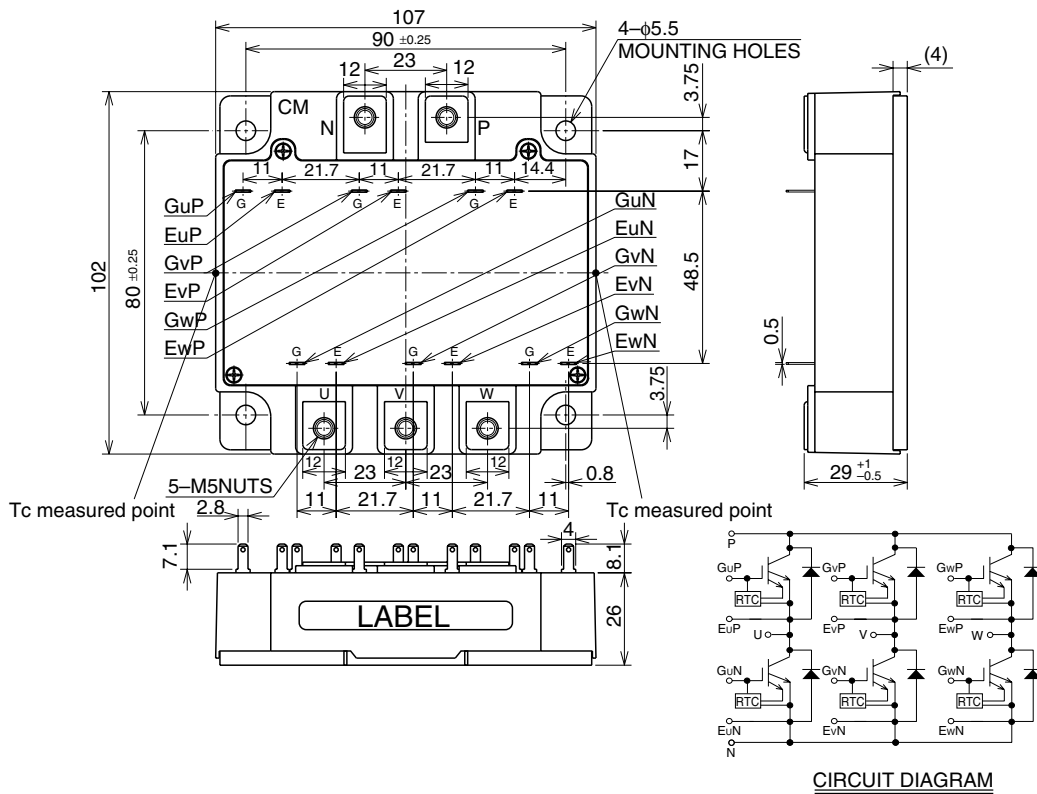

CM200TU-12F

HIGH POWER SWITCHING USE

MAXIMUM RATINGS (T<sub>j</sub> = 25°C, unless otherwise specified)

Symbol	Parameter	Conditions	Ratings	Unit
V <sub>CES</sub>	Collector-emitter voltage	G-E Short	600	V
V <sub>GES</sub>	Gate-emitter voltage	C-E Short	±20	V
I <sub>C</sub>	Collector current	T <sub>c</sub> = 25°C	200	A
I <sub>CM</sub>		Pulse (Note 2)	400	
I <sub>E</sub> (Note 1)	Emitter current	T <sub>c</sub> = 25°C	200	A
I <sub>EM</sub> (Note 1)		Pulse (Note 2)	400	
P <sub>C</sub> (Note 3)	Maximum collector dissipation	T <sub>c</sub> = 25°C	590	W
T <sub>j</sub>	Junction temperature		-40 ~ +150	°C
T <sub>stg</sub>	Storage temperature		-40 ~ +125	°C
V <sub>iso</sub>	Isolation voltage	Terminals to base plate, f = 60Hz, AC 1 minute	2500	V <sub>rms</sub>
—	Torque strength	Main terminals M5 screw	2.5 ~ 3.5	N • m
		Mounting M5 screw	2.5 ~ 3.5	N • m
—	Weight	Typical value	680	g

ELECTRICAL CHARACTERISTICS (T<sub>j</sub> = 25°C, unless otherwise specified)

Symbol	Parameter	Test conditions	Limits			Unit
			Min.	Typ.	Max.	
I <sub>CES</sub>	Collector cutoff current	V <sub>CE</sub> = V <sub>CES</sub> , V <sub>GE</sub> = 0V	—	—	1	mA
V <sub>GE(th)</sub>	Gate-emitter threshold voltage	I <sub>C</sub> = 20mA, V <sub>CE</sub> = 10V	5	6	7	V
I <sub>GES</sub>	Gate leakage current	±V <sub>GE</sub> = V <sub>GES</sub> , V <sub>CE</sub> = 0V	—	—	20	µA
V <sub>CE(sat)</sub>	Collector-emitter saturation voltage	I <sub>C</sub> = 200A, V <sub>GE</sub> = 15V	T <sub>j</sub> = 25°C		2.2	V
			T <sub>j</sub> = 125°C		—	
C <sub>ies</sub>	Input capacitance	V <sub>CE</sub> = 10V V <sub>GE</sub> = 0V	—	—	54	nF
C <sub>oes</sub>	Output capacitance		—	—	3.6	
C <sub>res</sub>	Reverse transfer capacitance		—	—	2.0	
Q <sub>G</sub>	Total gate charge	V <sub>CC</sub> = 300V, I <sub>C</sub> = 200A, V <sub>GE</sub> = 15V	—	1240	—	nC
t <sub>d(on)</sub>	Turn-on delay time	V <sub>CC</sub> = 300V, I <sub>C</sub> = 200A V <sub>GE</sub> = ±15V R <sub>G</sub> = 3.1Ω, Inductive load I <sub>E</sub> = 200A	—	—	120	ns
t <sub>r</sub>	Turn-on rise time		—	—	100	
t <sub>d(off)</sub>	Turn-off delay time		—	—	350	
t <sub>f</sub>	Turn-off fall time		—	—	250	
t <sub>rr</sub> (Note 1)	Reverse recovery time		—	—	150	
Q <sub>rr</sub> (Note 1)	Reverse recovery charge	—	3.8	—	µC	
V <sub>EC</sub> (Note 1)	Emitter-collector voltage	I <sub>E</sub> = 200A, V <sub>GE</sub> = 0V	—	—	2.6	V
R <sub>th(j-c)Q</sub>	Thermal resistance*1	IGBT part (1/6 module)	—	—	0.21	K/W
R <sub>th(j-c)R</sub>		FWDi part (1/6 module)	—	—	0.35	
R <sub>th(c-f)</sub>	Contact thermal resistance	Case to heat sink, Thermal compound applied*2 (1/6 module)	—	0.09	—	
R <sub>th(j-c')Q</sub>	Thermal resistance	Case temperature measured point is just under the chips	—	—	0.15*3	
R <sub>G</sub>	External gate resistance		3.1	—	31	Ω

Note 1. I<sub>E</sub>, V<sub>EC</sub>, t<sub>rr</sub>, Q<sub>rr</sub> & die/dt represent characteristics of the anti-parallel, emitter-collector free-wheel diode (FWDi).  
 2. Pulse width and repetition rate should be such that the device junction temperature (T<sub>j</sub>) does not exceed T<sub>jmax</sub> rating.  
 3. Junction temperature (T<sub>j</sub>) should not increase beyond 150°C.  
 4. Pulse width and repetition rate should be such as to cause negligible temperature rise.  
 \*1 : Case temperature (T<sub>c</sub>) measured point is indicated in OUTLINE DRAWING.  
 \*2 : Typical value is measured by using thermally conductive grease of λ = 0.9[W/(m • K)].  
 \*3 : If you use this value, R<sub>th(f-a)</sub> should be measured just under the chips.

PERFORMANCE CURVES

OUTPUT CHARACTERISTICS (TYPICAL)

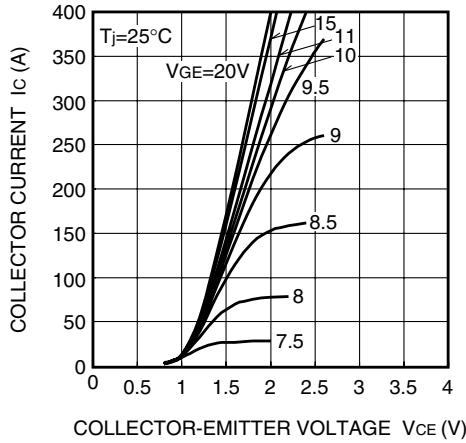

COLLECTOR-EMITTER SATURATION VOLTAGE CHARACTERISTICS (TYPICAL)

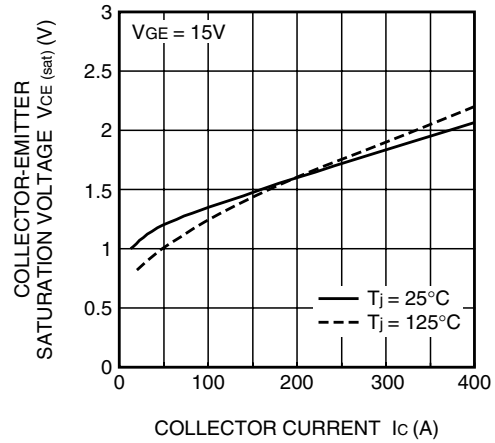

COLLECTOR-EMITTER SATURATION VOLTAGE CHARACTERISTICS (TYPICAL)

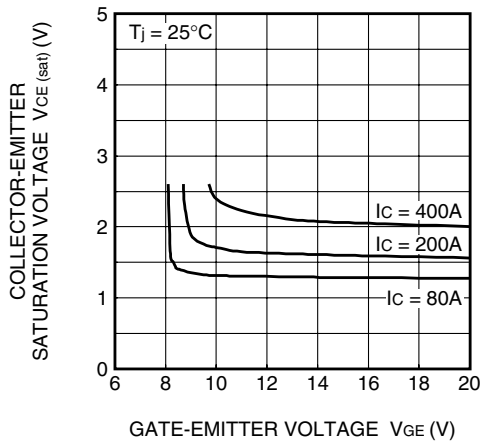

FREE-WHEEL DIODE FORWARD CHARACTERISTICS (TYPICAL)

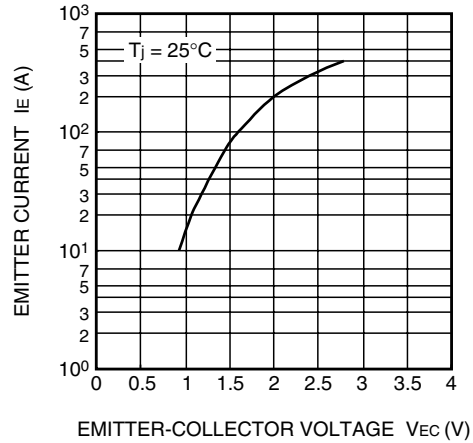

CAPACITANCE-Vce CHARACTERISTICS (TYPICAL)

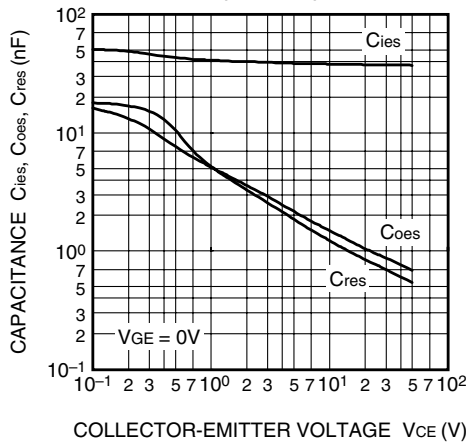

HALF-BRIDGE SWITCHING CHARACTERISTICS (TYPICAL)

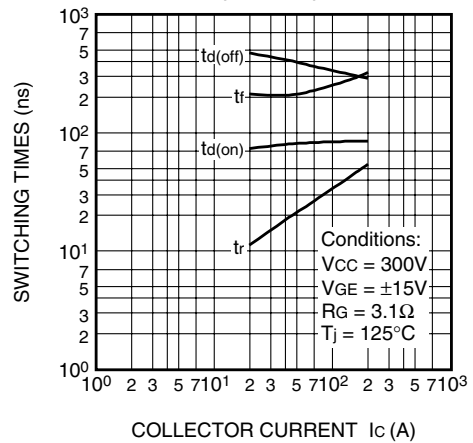

REVERSE RECOVERY CHARACTERISTICS OF FREE-WHEEL DIODE (TYPICAL)

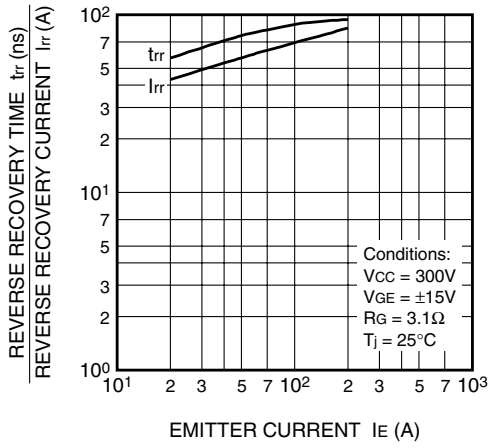

TRANSIENT THERMAL IMPEDANCE CHARACTERISTICS (IGBT part & FWDi part)

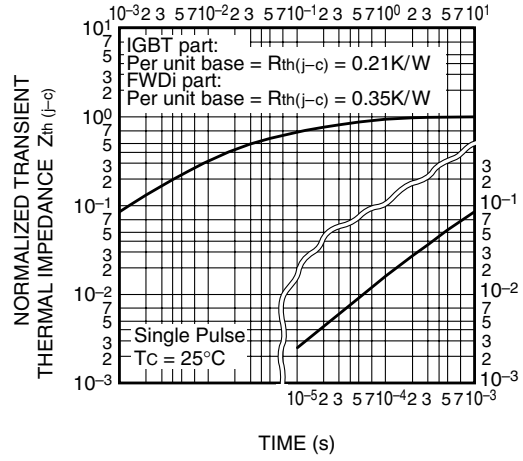

GATE CHARGE CHARACTERISTICS (TYPICAL)

