

MITSUBISHI IGBT MODULES

CM350DU-5F

HIGH POWER SWITCHING USE
INSULATED TYPE

CM350DU-5F



- Ic 350A
- VCES 250V
- Insulated Type
- 2-elements in a pack
- UL Recognized

Yellow Card No. E80276

File No. E80271

APPLICATION

UPS, Forklift

OUTLINE DRAWING & CIRCUIT DIAGRAM

Dimensions in mm

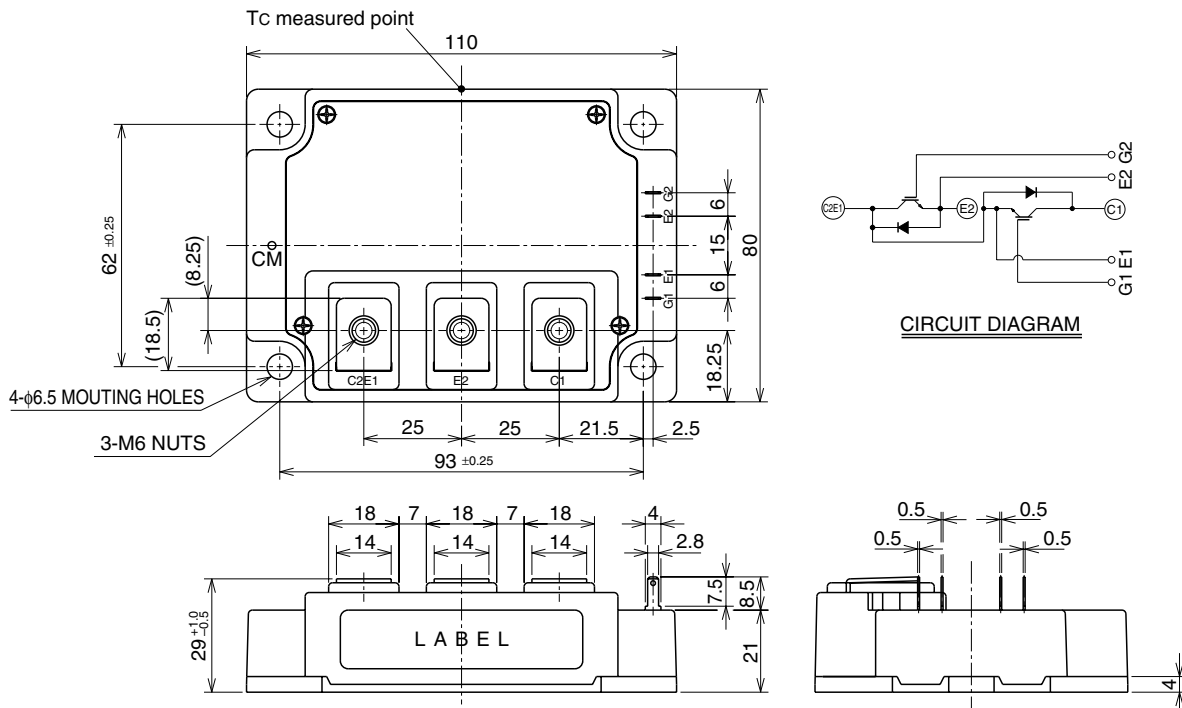

CM350DU-5F

**HIGH POWER SWITCHING USE
INSULATED TYPE**

MAXIMUM RATINGS (T_j = 25°C, unless otherwise specified)

Symbol	Parameter	Conditions	Ratings	Unit
V _{CE}	Collector-emitter voltage	G-E Short	250	V
V _{GE}	Gate-emitter voltage	C-E Short	±20	V
I _C	Collector current	T _C = 25°C	350	A
I _{CM}		Pulse (Note 2)	700	A
I _E (Note 1)	Emitter current	T _C = 25°C	350	A
I _{EM} (Note 1)		Pulse (Note 2)	700	A
P _C (Note 3)	Maximum collector dissipation	T _C = 25°C	960	W
T _j	Junction temperature	—	-40 ~ +150	°C
T _{stg}	Storage temperature	—	-40 ~ +125	°C
V _{iso}	Isolation voltage	Charged part to base plate, f = 60Hz, AC 1 minute	2500	V _{rms}
—	Torque strength	Main terminals M6 screw	1.96 ~ 2.94	N • m
		Mounting M6 screw	1.96 ~ 2.94	N • m
—	Weight	Typical value	520	g

ELECTRICAL CHARACTERISTICS (T_j = 25°C, unless otherwise specified)

Symbol	Parameter	Test conditions	Limits			Unit
			Min	Typ	Max	
I _{CE}	Collector cutoff current	V _{CE} = V _{CE} , V _{GE} = 0V	—	—	1	mA
V _{GE(th)}	Gate-emitter threshold voltage	I _C = 35mA, V _{CE} = 10V	3.0	4.0	5.0	V
I _{GES}	Gate-leakage current	±V _{GE} = V _{GES} , V _{CE} = 0V	—	—	0.5	μA
V _{CE(sat)}	Collector-emitter saturation voltage	I _C = 350A, V _{GE} = 10V (Note 4)	T _j = 25°C — T _j = 125°C —	1.2 1.10	1.7 —	V
C _{ies}	Input capacitance	V _{CE} = 10V	—	—	99	nF
C _{oes}	Output capacitance	V _{GE} = 0V	—	—	4.5	nF
C _{res}	Reverse transfer capacitance	—	—	—	3.4	nF
Q _G	Total gate charge	V _{CC} = 100V, I _C = 350A, V _{GE} = 10V	—	1320	—	nC
t _{d(on)}	Turn-on delay time	V _{CC} = 100V, I _C = 350A	—	—	1100	ns
t _r	Turn-on rise time	V _{GE} = ±10V	—	—	2400	ns
t _{d(off)}	Turn-off delay time	R _G = 7.1Ω	—	—	900	ns
t _f	Turn-off fall time	Resistive load	—	—	500	ns
V _{EC} (Note 1)	Emitter-collector voltage	I _E = 350A, V _{GE} = 0V	—	—	2.0	V
t _{rr} (Note 1)	Reverse recovery time	I _E = 350A,	—	—	300	ns
Q _{rr} (Note 1)	Reverse recovery charge	die / dt = -700A / μs	—	5.7	—	μC
R _{th(j-c)Q}	Thermal resistance (Note 5)	Junction to case, IGBT part (Per 1/2 module)	—	—	0.13	K/W
R _{th(j-c)R}		Junction to case, FWDi part (Per 1/2 module)	—	—	0.19	K/W
R _{th(c-f)}	Contact thermal resistance	Case to heat sink, conductive grease applied (Per 1/2 module) (Note 6)	—	0.02	—	K/W

- Note 1. I_E, V_{EC}, t_{rr}, Q_{rr} & die/dt represent characteristics of the anti-parallel, emitter-collector free-wheel diode (FWDi).
 2. Pulse width and repetition rate should be such that the device junction temperature (T_j) does not exceed T_{jmax} rating.
 3. Junction temperature (T_j) should not increase beyond 150°C.
 4. Pulse width and repetition rate should be such as to cause negligible temperature rise.
 5. Case temperature (T_c) measured point is indicated in OUTLINE DRAWING.
 6. Typical value is measured by using thermally conductive grease of λ = 0.9[W/(m • K)].

CM350DU-5F

HIGH POWER SWITCHING USE
INSULATED TYPE

PERFORMANCE CURVES

OUTPUT CHARACTERISTICS (TYPICAL)

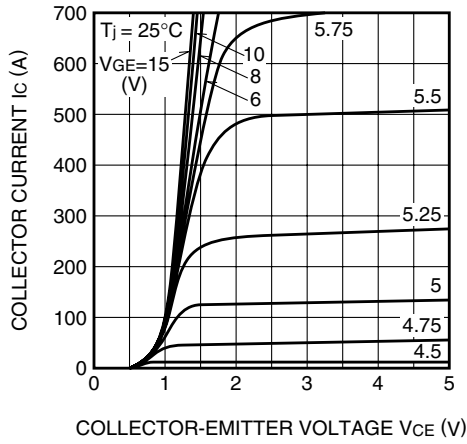

TRANSFER CHARACTERISTICS (TYPICAL)

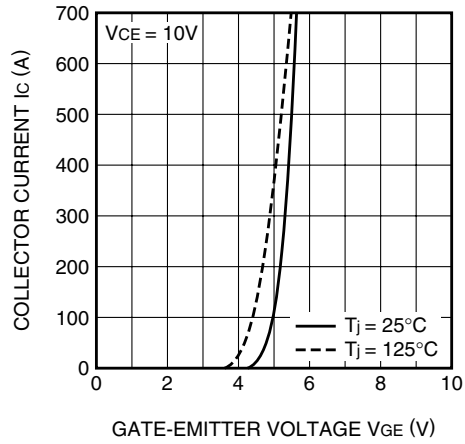

COLLECTOR-EMITTER SATURATION VOLTAGE CHARACTERISTICS (TYPICAL)

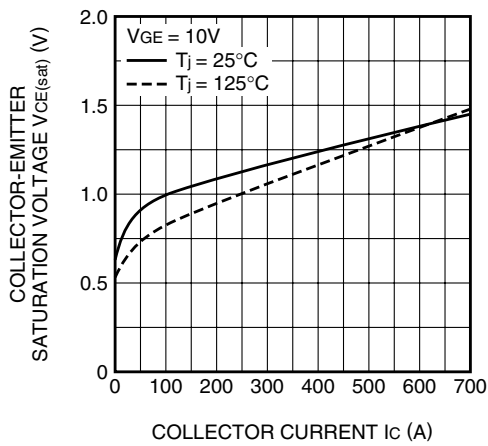

COLLECTOR-EMITTER SATURATION VOLTAGE CHARACTERISTICS (TYPICAL)

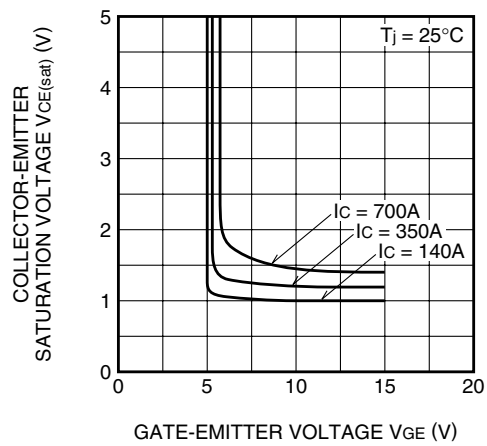

FREE-WHEEL DIODE FORWARD CHARACTERISTICS (TYPICAL)

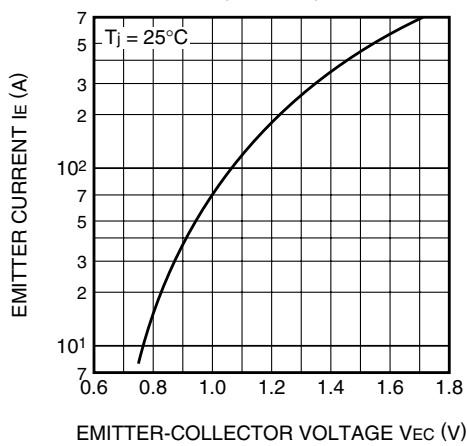

CAPACITANCE CHARACTERISTICS (TYPICAL)

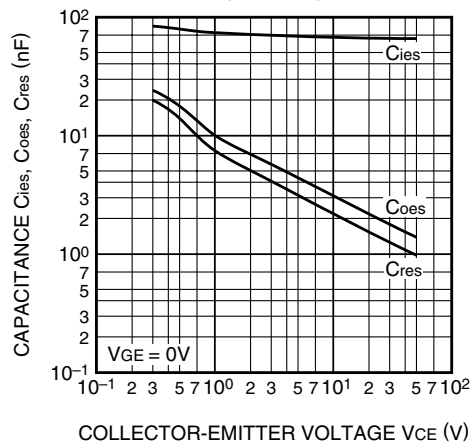

CM350DU-5F

HIGH POWER SWITCHING USE
INSULATED TYPE

**HALF-BRIDGE
SWITCHING TIME CHARACTERISTICS
(TYPICAL)**

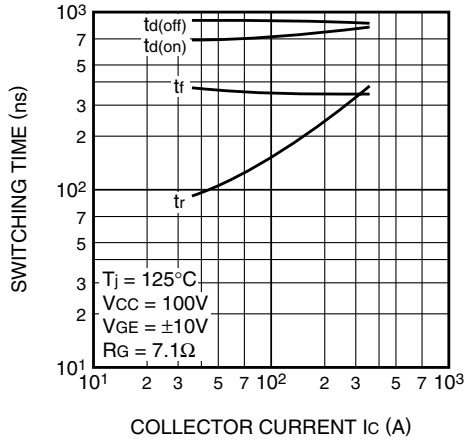

**REVERSE RECOVERY CHARACTERISTICS
OF FREE-WHEEL DIODE
(TYPICAL)**

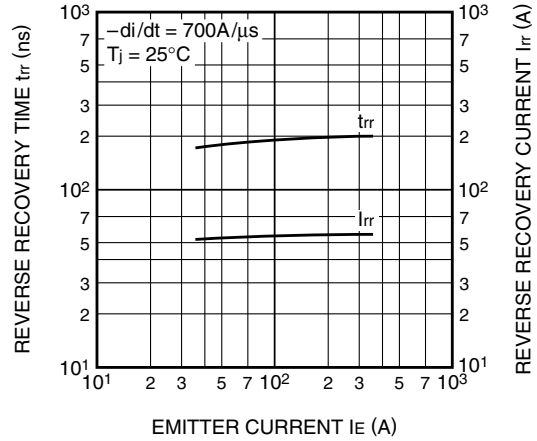

**TRANSIENT THERMAL
IMPEDANCE CHARACTERISTICS
(IGBT part)**

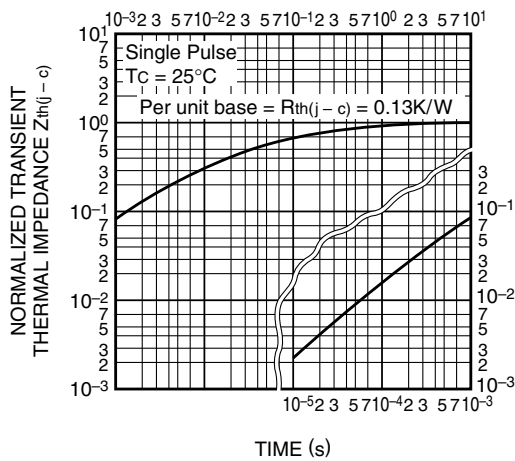

**TRANSIENT THERMAL
IMPEDANCE CHARACTERISTICS
(FWDi part)**

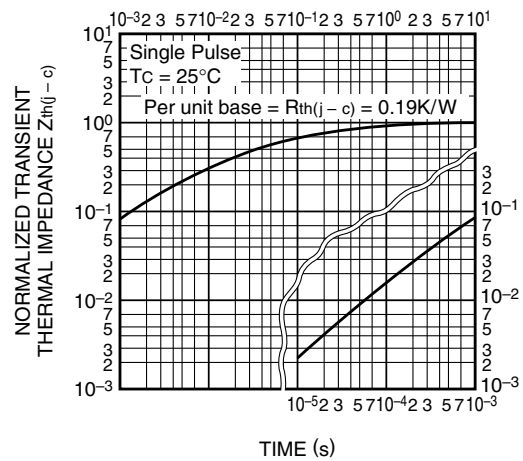

**GATE CHARGE CHARACTERISTICS
(TYPICAL)**

