

MITSUBISHI IGBT MODULES
CM400DU-12H
 HIGH POWER SWITCHING USE
 INSULATED TYPE

CM400DU-12H



- Ic 400A
- VCES 600V
- Insulated Type
- 2-elements in a pack
- UL Recognized

Yellow Card No. E80276
 File No. E80271

APPLICATION

UPS, NC machine, AC-Drive control, Servo, Welders

OUTLINE DRAWING & CIRCUIT DIAGRAM

Dimensions in mm

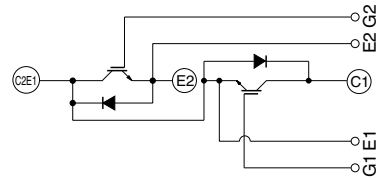
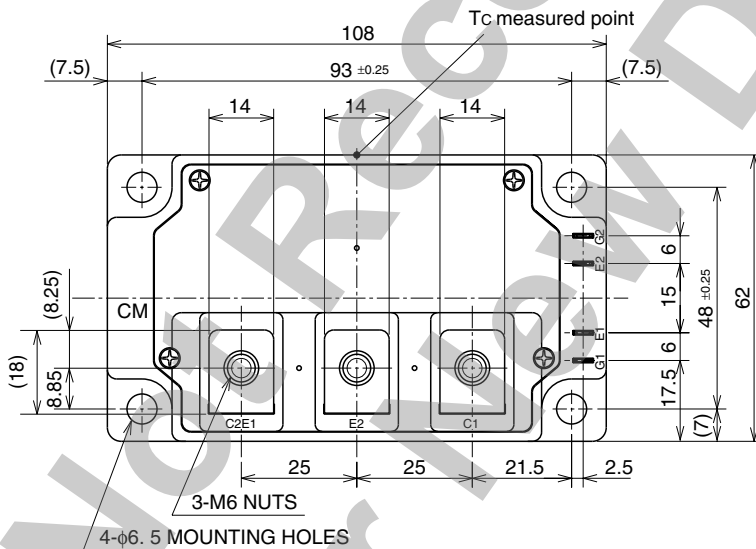

CIRCUIT DIAGRAM

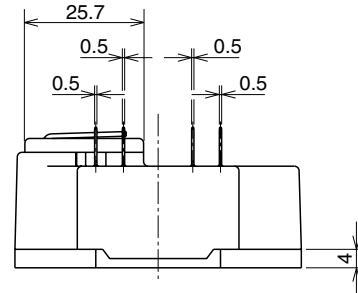
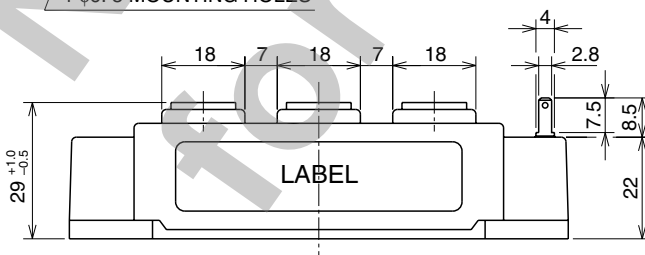

CM400DU-12H

**HIGH POWER SWITCHING USE
INSULATED TYPE**

MAXIMUM RATINGS (T_j = 25°C, unless otherwise specified)

| Symbol | Item | Conditions | Ratings | Unit |
|--------------------------|-------------------------------|---|------------|------------------|
| V _{CEs} | Collector-emitter voltage | V _{GE} = 0V | 600 | V |
| V _{GES} | Gate-emitter voltage | V _{CE} = 0V | ±20 | V |
| I _C | Collector current | T _C = 25°C | 400 | A |
| I _{CM} | | Pulse (Note 1) | 800 | A |
| I _E (Note 2) | Emitter current | T _C = 25°C | 400 | A |
| I _{EM} (Note 2) | | Pulse (Note 1) | 800 | A |
| P _C (Note 3) | Maximum collector dissipation | T _C = 25°C | 1130 | W |
| T _j | Junction temperature | — | -40 ~ +150 | °C |
| T _{stg} | Storage temperature | — | -40 ~ +125 | °C |
| V _{iso} | Isolation voltage | Charged part to base plate, f = 60Hz, AC 1 minute | 2500 | V _{rms} |
| — | Mounting torque | Main terminals M6 screw | 3.5 ~ 4.5 | N·m |
| | | Mounting M6 screw | 3.5 ~ 4.5 | N·m |
| — | Weight | Typical value | 400 | g |

ELECTRICAL CHARACTERISTICS (T_j = 25°C, unless otherwise specified)

| Symbol | Item | Test Conditions | Limits | | | Unit |
|--------------------------|--------------------------------------|--|--------|------|------|------|
| | | | Min | Typ | Max | |
| I _{CEs} | Collector cutoff current | V _{CE} = V _{CEs} , V _{GE} = 0V | — | — | 1 | mA |
| V _{GE(th)} | Gate-emitter threshold voltage | I _C = 40mA, V _{CE} = 10V | 4.5 | 6 | 7.5 | V |
| I _{GES} | Gate-leakage current | ±V _{GE} = V _{GES} , V _{CE} = 0V | — | — | 0.5 | µA |
| V _{CE(sat)} | Collector-emitter saturation voltage | I _C = 400A, V _{GE} = 15V (Note 4) | — | 2.4 | 3.0 | V |
| | | T _j = 125°C | — | 2.6 | — | |
| C _{ies} | Input capacitance | V _{CE} = 10V | — | — | 35.2 | nF |
| C _{oes} | Output capacitance | V _{GE} = 0V | — | — | 19.2 | nF |
| C _{res} | Reverse transfer capacitance | — | — | — | 5.2 | nF |
| Q _G | Total gate charge | V _{CC} = 300V, I _C = 400A, V _{GE} = 15V | — | 800 | — | nC |
| t _{d(on)} | Turn-on delay time | V _{CC} = 300V, I _C = 400A | — | — | 250 | ns |
| t _r | Turn-on rise time | V _{GE} = ±15V | — | — | 600 | ns |
| t _{d(off)} | Turn-off delay time | R _G = 1.6Ω | — | — | 350 | ns |
| t _f | Turn-off fall time | Resistive load | — | — | 300 | ns |
| V _{EC} (Note 2) | Emitter-collector voltage | I _E = 400A, V _{GE} = 0V | — | — | 2.6 | V |
| t _{rr} (Note 2) | Reverse recovery time | I _E = 400A, | — | — | 160 | ns |
| Q _{rr} (Note 2) | Reverse recovery charge | die / dt = -800A / µs | — | 0.96 | — | µC |
| R _{th(j-c)Q} | Thermal resistance (Note 5) | Junction to case, IGBT part (Per 1/2 module) | — | — | 0.11 | K/W |
| R _{th(j-c)R} | | Junction to case, FWDi part (Per 1/2 module) | — | — | 0.18 | K/W |
| R _{th(c-f)} | Contact thermal resistance | Case to heat sink, conductive grease applied (Per 1/2 module) (Note 6) | — | 0.04 | — | K/W |

- Note 1. Pulse width and repetition rate should be such that the device junction temperature (T_j) does not exceed T_{jmax} rating.
 2. I_E, I_{EM}, V_{EC}, t_{rr}, Q_{rr} & die/dt represent characteristics of the anti-parallel, emitter-collector free-wheel diode.
 3. Junction temperature (T_j) should not increase beyond 150°C.
 4. Pulse width and repetition rate should be such as to cause negligible temperature rise.
 5. Case temperature (T_C) measured point is shown in page OUTLINE DRAWING.
 6. Typical value is measured by using thermally conductive grease of λ = 0.9[W/(m · K)].

CM400DU-12H

HIGH POWER SWITCHING USE
INSULATED TYPE

PERFORMANCE CURVES

OUTPUT CHARACTERISTICS
(TYPICAL)

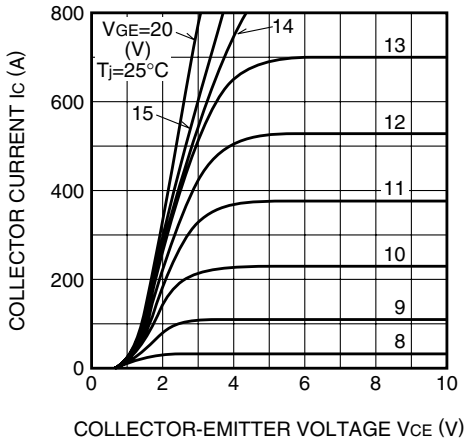

TRANSFER CHARACTERISTICS
(TYPICAL)

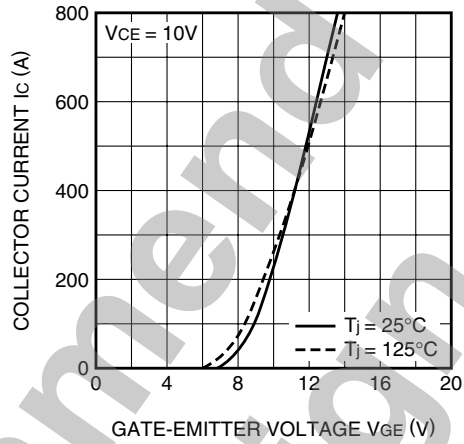

COLLECTOR-EMITTER SATURATION
VOLTAGE CHARACTERISTICS
(TYPICAL)

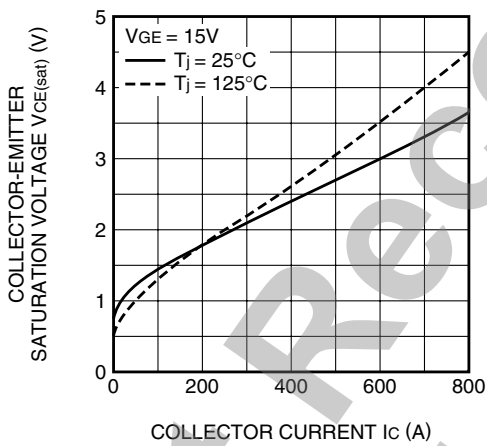

COLLECTOR-EMITTER SATURATION
VOLTAGE CHARACTERISTICS
(TYPICAL)

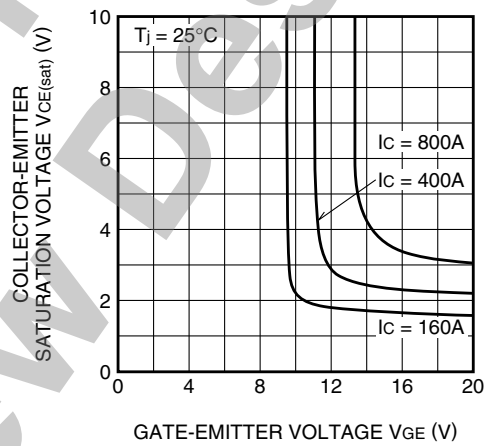

FREE-WHEEL DIODE
FORWARD CHARACTERISTICS
(TYPICAL)

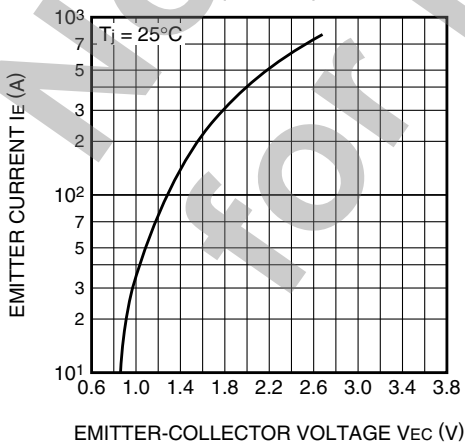

CAPACITANCE CHARACTERISTICS
(TYPICAL)

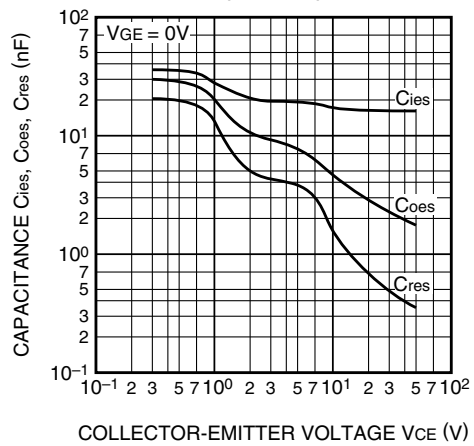

CM400DU-12H

HIGH POWER SWITCHING USE
INSULATED TYPE

HALF-BRIDGE
SWITCHING TIME CHARACTERISTICS
(TYPICAL)

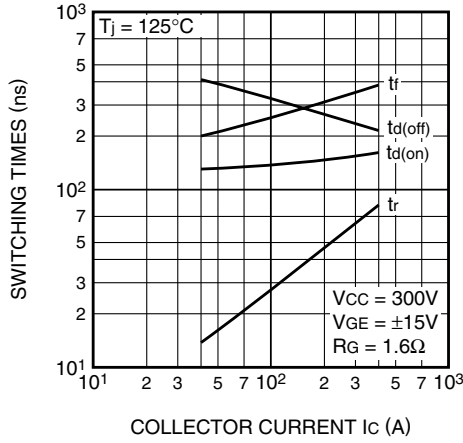

REVERSE RECOVERY CHARACTERISTICS
OF FREE-WHEEL DIODE
(TYPICAL)

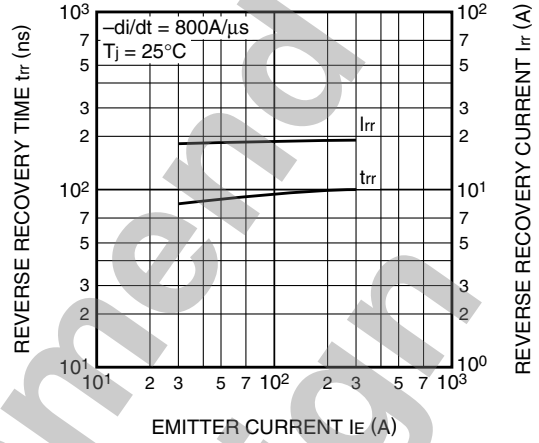

TRANSIENT THERMAL
IMPEDANCE CHARACTERISTICS
(IGBT part)

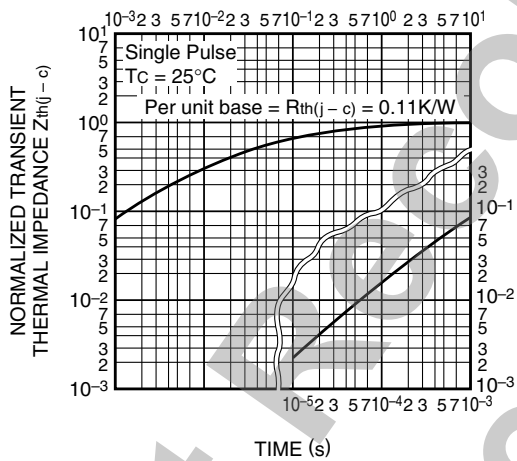

TRANSIENT THERMAL
IMPEDANCE CHARACTERISTICS
(FWDi part)

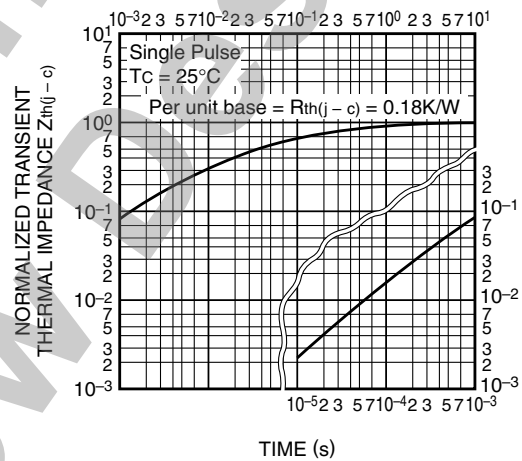

GATE CHARGE CHARACTERISTICS
(TYPICAL)

