

< IGBT MODULES >

# CM600DXL-34SA

HIGH POWER SWITCHING USE  
INSULATED TYPE

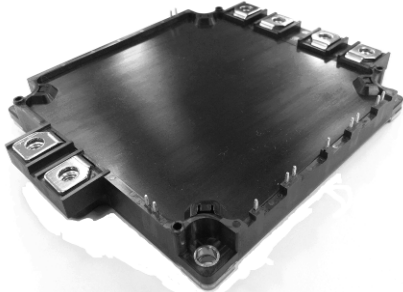

**Dual switch (Half-Bridge)**

Collector current  $I_C$  ..... **600 A**  
 Collector-emitter voltage  $V_{CES}$  ..... **1700 V**  
 Maximum junction temperature  $T_{jmax}$  ..... **175 °C**

- Flat base Type
- Copper base plate (non-plating)
- Tin plating pin terminals
- RoHS Directive compliance
- Recognized under UL1557, File E323585

## APPLICATION

Wind power, AC Motor Control, Motion/Servo Control, Power supply, etc.

## OUTLINE DRAWING & INTERNAL CONNECTION

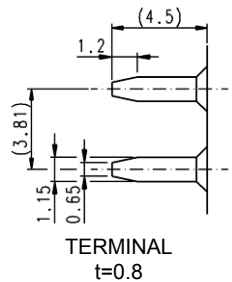
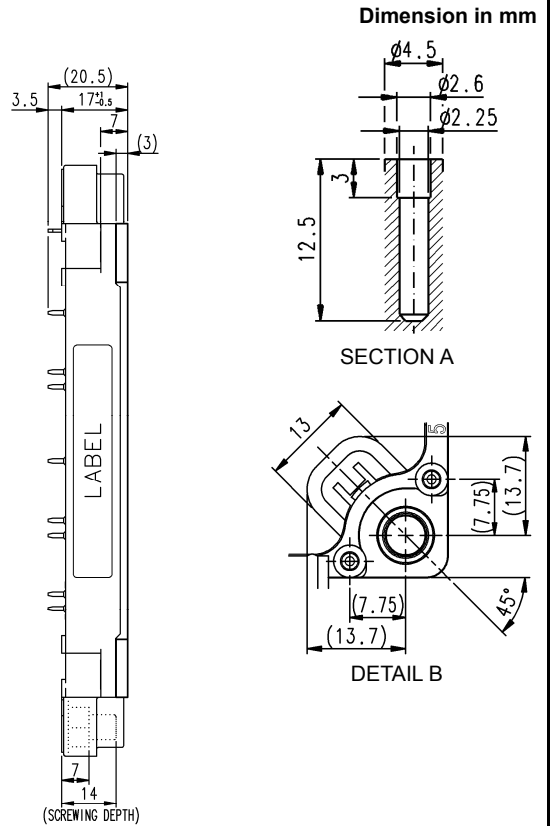
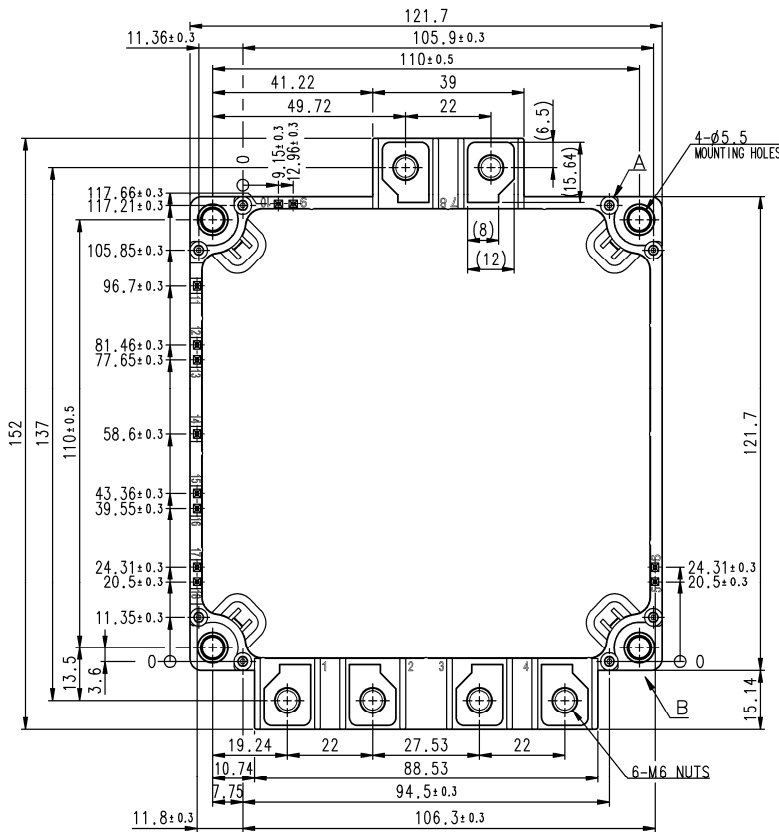

Tolerance otherwise specified

| Division of Dimension | Tolerance |
|-----------------------|-----------|
| 0.5 to 3              | ±0.2      |
| over 3 to 6           | ±0.3      |
| over 6 to 30          | ±0.5      |
| over 30 to 120        | ±0.8      |
| over 120 to 400       | ±1.2      |

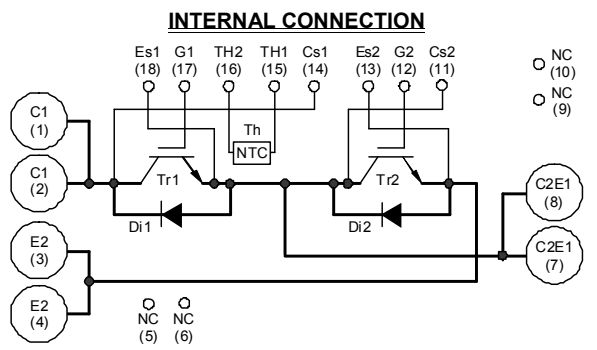

< IGBT MODULES >

CM600DXL-34SA

HIGH POWER SWITCHING USE  
INSULATED TYPE

MAXIMUM RATINGS ( $T_j=25\text{ }^\circ\text{C}$ , unless otherwise specified)

INVERTER PART IGBT/DIODE

| Symbol            | Item                      | Conditions                                     | Rating   | Unit |
|-------------------|---------------------------|--|----------|------|
| $V_{CES}$         | Collector-emitter voltage | G-E short-circuited                            | 1700     | V    |
| $V_{GES}$         | Gate-emitter voltage      | C-E short-circuited                            | $\pm 20$ | V    |
| $I_C$             | Collector current         | DC, $T_C=125\text{ }^\circ\text{C}$ (Note2, 4) | 600      | A    |
| $I_{CRM}$         |                           | Pulse, Repetitive (Note3)                      | 1200     |      |
| $P_{tot}$         | Total power dissipation   | $T_C=25\text{ }^\circ\text{C}$ (Note2, 4)      | 5760     | W    |
| $I_E$ (Note1)     | Emitter current           | DC (Note2)                                     | 600      | A    |
| $I_{ERM}$ (Note1) |                           | Pulse, Repetitive (Note3)                      | 1200     |      |

MODULE

| Symbol     | Item                           | Conditions                                      | Rating     | Unit             |
|------------|--------------------------------|---|------------|------------------|
| $V_{isol}$ | Isolation voltage              | Terminals to base plate, RMS, f=60 Hz, AC 1 min | 4000       | V                |
| $T_{jmax}$ | Maximum junction temperature   | Instantaneous event (overload)                  | 175        | $^\circ\text{C}$ |
| $T_{Cmax}$ | Maximum case temperature       | (Note4)   | 125        |                  |
| $T_{jop}$  | Operating junction temperature | Continuous operation (under switching)          | -40 ~ +150 | $^\circ\text{C}$ |
| $T_{stg}$  | Storage temperature            | -   | -40 ~ +125 |                  |

ELECTRICAL CHARACTERISTICS ( $T_j=25\text{ }^\circ\text{C}$ , unless otherwise specified)

INVERTER PART IGBT/DIODE

| Symbol                         | Item                                 | Conditions   | Limits                          |      |      | Unit          |   |
|--------------------------------|--------------------------------------|--|---------------------------------|------|------|---------------|---|
|                                |                                      |  | Min.                            | Typ. | Max. |               |   |
| $I_{CES}$                      | Collector-emitter cut-off current    | $V_{CE}=V_{CES}$ , G-E short-circuited   | -                               | -    | 1.0  | mA            |   |
| $I_{GES}$                      | Gate-emitter leakage current         | $V_{GE}=V_{GES}$ , C-E short-circuited   | -                               | -    | 0.5  | $\mu\text{A}$ |   |
| $V_{GE(th)}$                   | Gate-emitter threshold voltage       | $I_C=60\text{ mA}$ , $V_{CE}=10\text{ V}$  | 5.4                             | 6.0  | 6.6  | V             |   |
| $V_{Cesat}$<br>(Terminal)      | Collector-emitter saturation voltage | $I_C=600\text{ A}$ , $V_{GE}=15\text{ V}$ ,<br>Refer to the figure of test circuit.<br>(Note6)                     | $T_j=25\text{ }^\circ\text{C}$  | -    | 2.00 | 2.50          | V |
|                                |                                      |  | $T_j=125\text{ }^\circ\text{C}$ | -    | 2.20 | -             |   |
|                                |                                      |  | $T_j=150\text{ }^\circ\text{C}$ | -    | 2.25 | -             |   |
| $V_{Cesat}$<br>(Chip)          |                                      | $I_C=600\text{ A}$ ,<br>$V_{GE}=15\text{ V}$ ,<br>(Note6)  | $T_j=25\text{ }^\circ\text{C}$  | -    | 1.90 | 2.40          | V |
|                                |                                      |  | $T_j=125\text{ }^\circ\text{C}$ | -    | 2.10 | -             |   |
|                                |                                      |  | $T_j=150\text{ }^\circ\text{C}$ | -    | 2.15 | -             |   |
| $C_{ies}$                      | Input capacitance                    | $V_{CE}=10\text{ V}$ , G-E short-circuited   | -                               | -    | 158  | nF            |   |
| $C_{oes}$                      | Output capacitance                   |  | -                               | -    | 13   |               |   |
| $C_{res}$                      | Reverse transfer capacitance         |  | -                               | -    | 2.9  |               |   |
| $Q_G$                          | Gate charge                          | $V_{CC}=1000\text{ V}$ , $I_C=600\text{ A}$ , $V_{GE}=15\text{ V}$   | -                               | 3310 | -    | nC            |   |
| $t_{d(on)}$                    | Turn-on delay time                   | $V_{CC}=1000\text{ V}$ , $I_C=600\text{ A}$ , $V_{GE}=\pm 15\text{ V}$ ,<br>$R_G=0\text{ }\Omega$ , Inductive load | -                               | -    | 900  | ns            |   |
| $t_r$                          | Rise time                            |  | -                               | -    | 150  |               |   |
| $t_{d(off)}$                   | Turn-off delay time                  |  | -                               | -    | 900  |               |   |
| $t_f$                          | Fall time                            |  | -                               | -    | 400  |               |   |
| $V_{EC}$ (Note1)<br>(Terminal) | Emitter-collector voltage            | $I_E=600\text{ A}$ , G-E short-circuited,<br>Refer to the figure of test circuit.<br>(Note6)                       | $T_j=25\text{ }^\circ\text{C}$  | -    | 4.1  | 5.3           | V |
|                                |                                      |  | $T_j=125\text{ }^\circ\text{C}$ | -    | 2.9  | -             |   |
|                                |                                      |  | $T_j=150\text{ }^\circ\text{C}$ | -    | 2.7  | -             |   |
| $V_{EC}$ (Note1)<br>(Chip)     |                                      | $I_E=600\text{ A}$ ,<br>G-E short-circuited,<br>(Note6)  | $T_j=25\text{ }^\circ\text{C}$  | -    | 4.0  | 5.2           | V |
|                                |                                      |  | $T_j=125\text{ }^\circ\text{C}$ | -    | 2.8  | -             |   |
|                                |                                      |  | $T_j=150\text{ }^\circ\text{C}$ | -    | 2.6  | -             |   |
| $t_{rr}$ (Note1)               | Reverse recovery time                | $V_{CC}=1000\text{ V}$ , $I_E=600\text{ A}$ , $V_{GE}=\pm 15\text{ V}$ ,<br>$R_G=0\text{ }\Omega$ , Inductive load | -                               | -    | 300  | ns            |   |
| $Q_{rr}$ (Note1)               | Reverse recovery charge              | $R_G=0\text{ }\Omega$ , Inductive load   | -                               | 23   | -    | $\mu\text{C}$ |   |
| $E_{on}$                       | Turn-on switching energy per pulse   | $V_{CC}=1000\text{ V}$ , $I_C=I_E=600\text{ A}$ ,  | -                               | 167  | -    | mJ            |   |
| $E_{off}$                      | Turn-off switching energy per pulse  | $V_{GE}=\pm 15\text{ V}$ , $R_G=0\text{ }\Omega$ , $T_j=150\text{ }^\circ\text{C}$ ,                               | -                               | 168  | -    |               |   |
| $E_{rr}$ (Note1)               | Reverse recovery energy per pulse    | Inductive load   | -                               | 106  | -    |               |   |
| $R_{CC+EE}$                    | Internal lead resistance             | Main terminals-chip, per switch,<br>$T_C=25\text{ }^\circ\text{C}$ (Note4)   | -                               | -    | 0.6  | m $\Omega$    |   |
| $r_g$                          | Internal gate resistance             | Per switch   | -                               | 2.4  | -    | $\Omega$      |   |

< IGBT MODULES >

CM600DXL-34SA

HIGH POWER SWITCHING USE  
INSULATED TYPE

ELECTRICAL CHARACTERISTICS (cont.; T<sub>j</sub>=25 °C, unless otherwise specified)

NTC THERMISTOR PART

| Symbol               | Item                    | Conditions  | Limits |      |      | Unit |
|----------------------|-------------------------|---|--------|------|------|------|
|                      |                         |   | Min.   | Typ. | Max. |      |
| R <sub>25</sub>      | Zero-power resistance   | T <sub>C</sub> =25 °C (Note4)                           | 4.85   | 5.00 | 5.15 | kΩ   |
| ΔR/R                 | Deviation of resistance | R <sub>100</sub> =493 Ω, T <sub>C</sub> =100 °C (Note4) | -7.3   | -    | +7.8 | %    |
| B <sub>(25/50)</sub> | B-constant              | Approximate by equation (Note6)                         | -      | 3375 | -    | K    |
| P <sub>25</sub>      | Power dissipation       | T <sub>C</sub> =25 °C (Note4)                           | -      | -    | 10   | mW   |

THERMAL RESISTANCE CHARACTERISTICS

| Symbol                | Item                       | Conditions  | Limits |      |      | Unit |
|-----------------------|----------------------------|---|--------|------|------|------|
|                       |                            |   | Min.   | Typ. | Max. |      |
| R <sub>th(j-c)Q</sub> | Thermal resistance         | Junction to case, per IGBT (Note4)                                    | -      | -    | 26   | K/kW |
| R <sub>th(j-c)D</sub> |                            | Junction to case, per DIODE (Note4)                                   | -      | -    | 39   |      |
| R <sub>th(c-s)</sub>  | Contact thermal resistance | Case to heat sink, per 1 module,<br>Thermal grease applied (Note4, 7) | -      | 7    | -    | K/kW |

MECHANICAL CHARACTERISTICS

| Symbol         | Item                   | Conditions                      | Limits |      |      | Unit |
|----------------|------------------------|---------------------------------|--------|------|------|------|
|                |                        |                                 | Min.   | Typ. | Max. |      |
| M <sub>t</sub> | Mounting torque        | Main terminals M 6 screw        | 3.5    | 4.0  | 4.5  | N·m  |
| M <sub>s</sub> |                        | Mounting to heat sink M 5 screw | 2.5    | 3.0  | 3.5  |      |
| d <sub>s</sub> | Creepage distance      | Terminal to terminal            | 22.5   | -    | -    | mm   |
|                |                        | Terminal to base plate          | 16.8   | -    | -    |      |
| d <sub>a</sub> | Clearance              | Terminal to terminal            | 15.5   | -    | -    | mm   |
|                |                        | Terminal to base plate          | 11.3   | -    | -    |      |
| m              | mass                   | -                               | -      | 690  | -    | g    |
| e <sub>c</sub> | Flatness of base plate | On the centerline X, Y (Note8)  | ± 0    | -    | +100 | μm   |

Note1. Represent ratings and characteristics of the anti-parallel, emitter-collector free wheeling diode (DIODE).

- Junction temperature (T<sub>j</sub>) should not increase beyond T<sub>jmax</sub> rating.
- Pulse width and repetition rate should be such that the device junction temperature (T<sub>j</sub>) dose not exceed T<sub>jmax</sub> rating.
- Case temperature (T<sub>C</sub>) and heat sink temperature (T<sub>s</sub>) are defined on the each surface (mounting side) of base plate and heat sink just under the chips. Refer to the figure of chip location.
- Pulse width and repetition rate should be such as to cause negligible temperature rise.

$$6. B_{(25/50)} = \ln\left(\frac{R_{25}}{R_{50}}\right) / \left(\frac{1}{T_{25}} - \frac{1}{T_{50}}\right),$$

R<sub>25</sub>: resistance at absolute temperature T<sub>25</sub> [K]; T<sub>25</sub>=25 [°C]+273.15=298.15 [K]

R<sub>50</sub>: resistance at absolute temperature T<sub>50</sub> [K]; T<sub>50</sub>=50 [°C]+273.15=323.15 [K]

7. Typical value is measured by using thermally conductive grease of λ=0.9 W/(m·K).

8. The base plate (mounting side) flatness measurement points (X, Y) are as follows of the following figure.

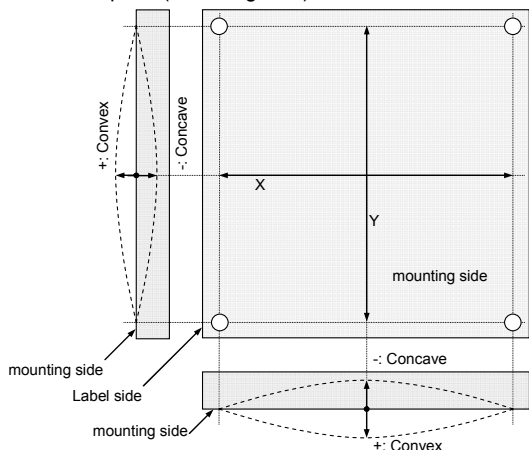

- Use the following screws when mounting the printed circuit board (PCB) on the stand offs.  
"φ2.6×10 or φ2.6×12 self tapping screw"  
The length of the screw depends on the thickness (t1.6~t2.0) of the PCB.

< IGBT MODULES >  
**CM600DXL-34SA**  
 HIGH POWER SWITCHING USE  
 INSULATED TYPE

**RECOMMENDED OPERATING CONDITIONS**

| Symbol     | Item                          | Conditions                   | Limits |      |      | Unit     |
|------------|-------------------------------|------------------------------|--------|------|------|----------|
|            |                               |                              | Min.   | Typ. | Max. |          |
| $V_{CC}$   | (DC) Supply voltage           | Applied across C1-E2         | -      | 1000 | 1200 | V        |
| $V_{GEon}$ | Gate (-emitter drive) voltage | Applied across G1-Es1/G2-Es2 | 13.5   | 15.0 | 16.5 | V        |
| $R_G$      | External gate resistance      | Per switch                   | 0      | -    | 13   | $\Omega$ |

**CHIP LOCATION (Top view)**

Dimension in mm, tolerance:  $\pm 1$  mm

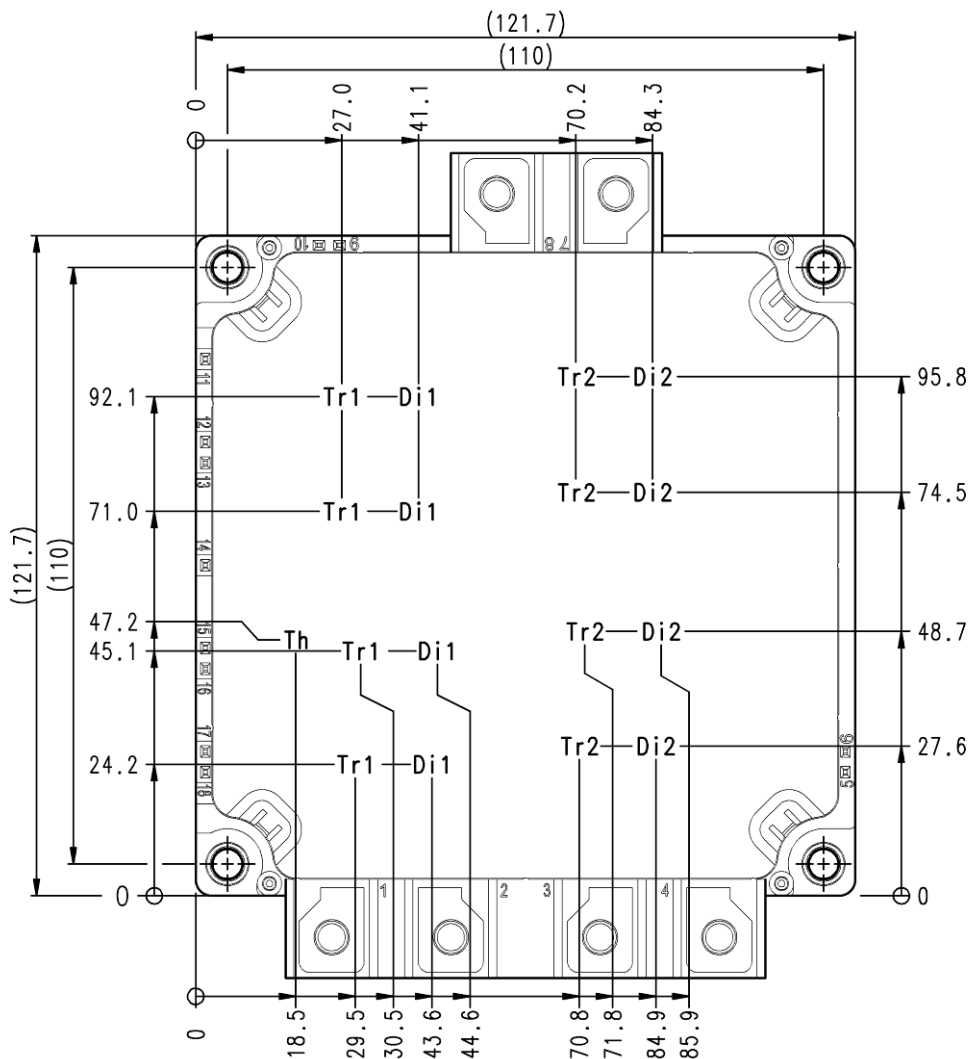

Tr1/Tr2: IGBT, Di1/Di2: DIODE, Th: NTC thermistor

< IGBT MODULES >

CM600DXL-34SA

HIGH POWER SWITCHING USE

INSULATED TYPE

TEST CIRCUIT

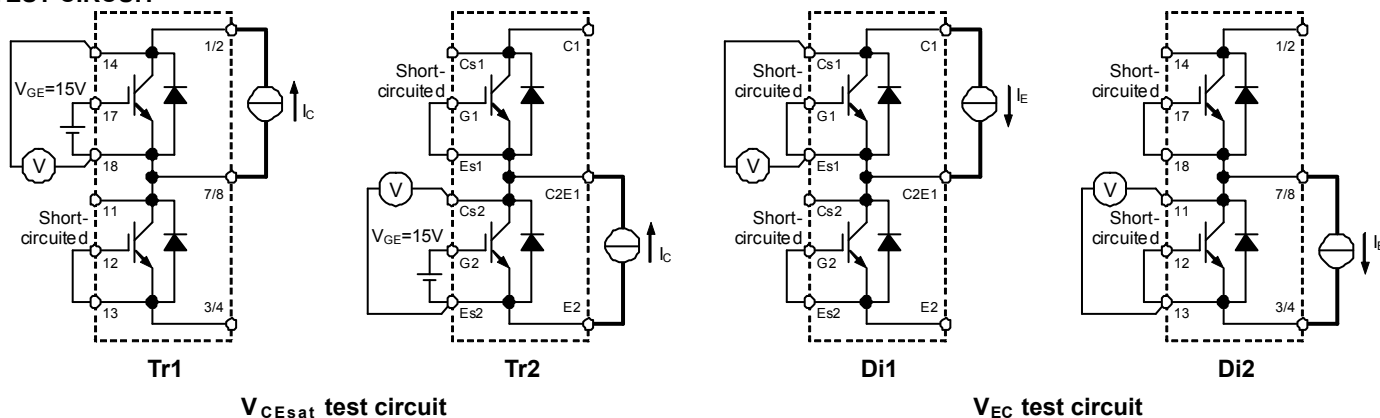

TEST CIRCUIT AND WAVEFORMS

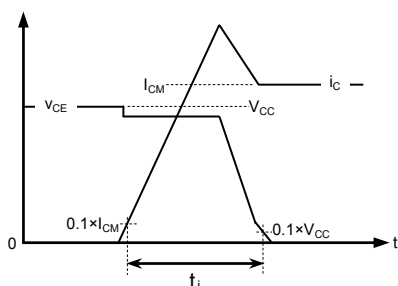
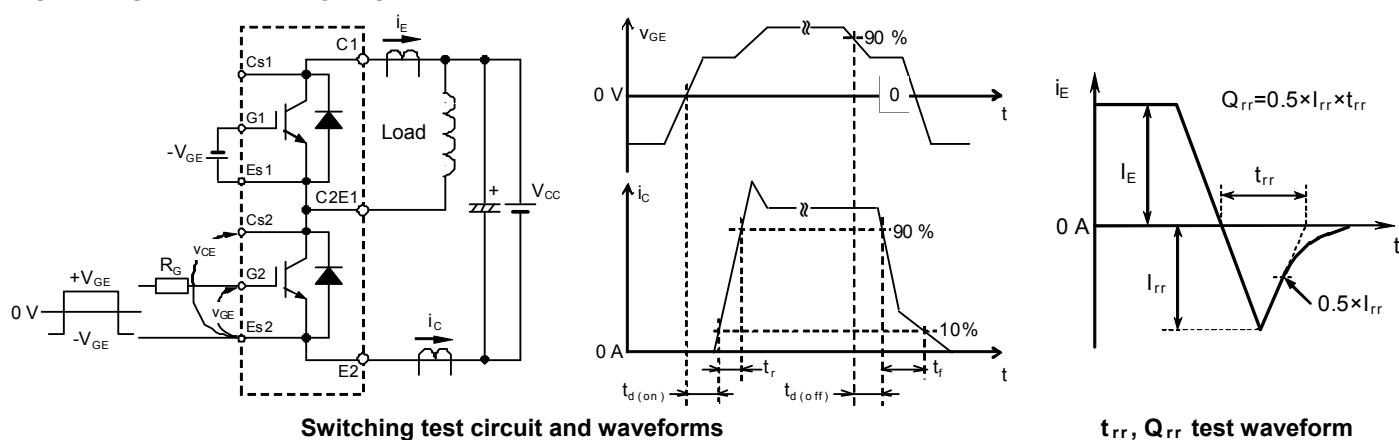

**IGBT Turn-on switching energy**

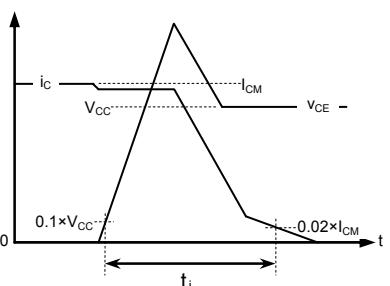

**IGBT Turn-off switching energy**

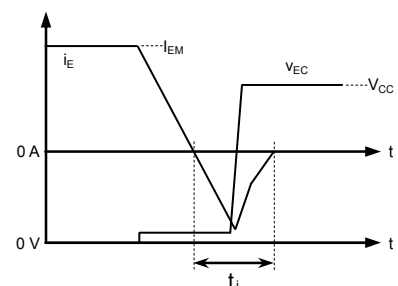

**DIODE Reverse recovery energy**

Turn-on / Turn-off switching energy and Reverse recovery energy test waveforms (Integral time instruction drawing)

< IGBT MODULES >  
**CM600DXL-34SA**  
 HIGH POWER SWITCHING USE  
 INSULATED TYPE

PERFORMANCE CURVES

INVERTER PART

OUTPUT CHARACTERISTICS  
 (TYPICAL)

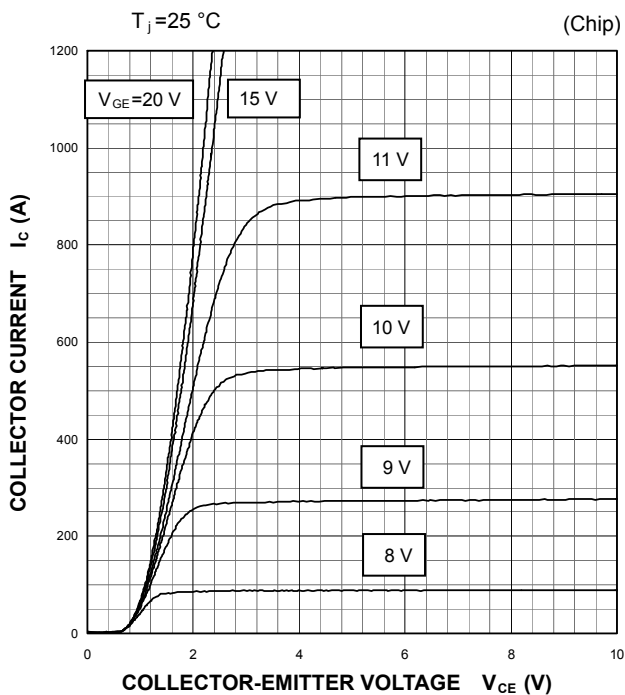

COLLECTOR-EMITTER SATURATION VOLTAGE  
 CHARACTERISTICS  
 (TYPICAL)

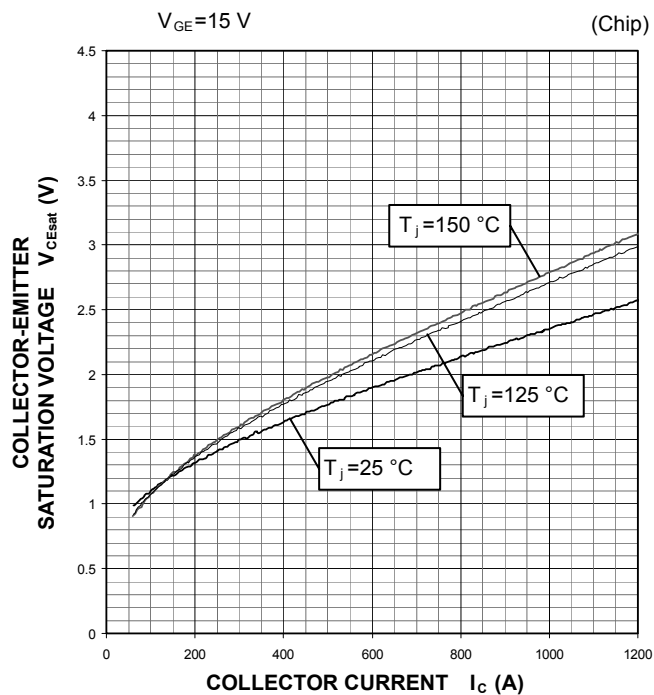

FREE WHEELING DIODE  
 FORWARD CHARACTERISTICS  
 (TYPICAL)

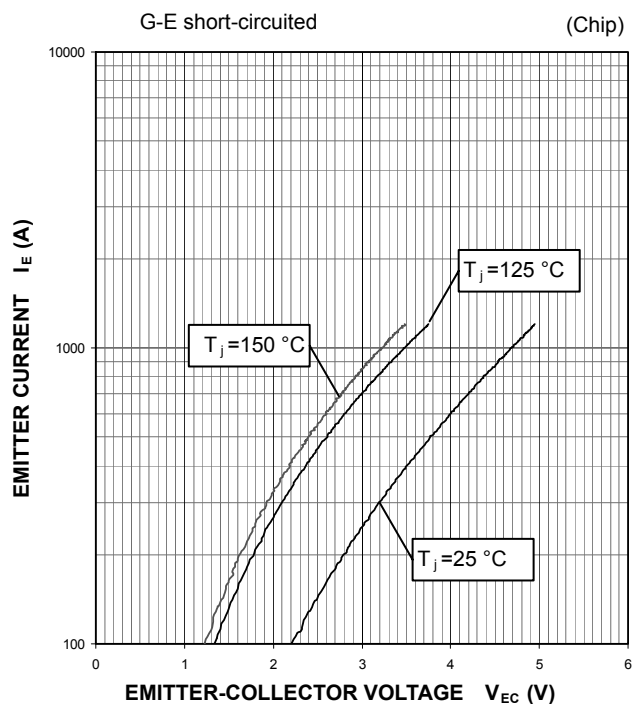

< IGBT MODULES >  
**CM600DXL-34SA**  
 HIGH POWER SWITCHING USE  
 INSULATED TYPE

PERFORMANCE CURVES

INVERTER PART

HALF-BRIDGE  
 SWITCHING CHARACTERISTICS  
 (TYPICAL)

$V_{CC}=1000\text{ V}$ ,  $V_{GE}=\pm 15\text{ V}$ ,  $R_G=0\ \Omega$ , INDUCTIVE LOAD  
 —:  $T_j=150\text{ }^\circ\text{C}$ , - - - -:  $T_j=125\text{ }^\circ\text{C}$

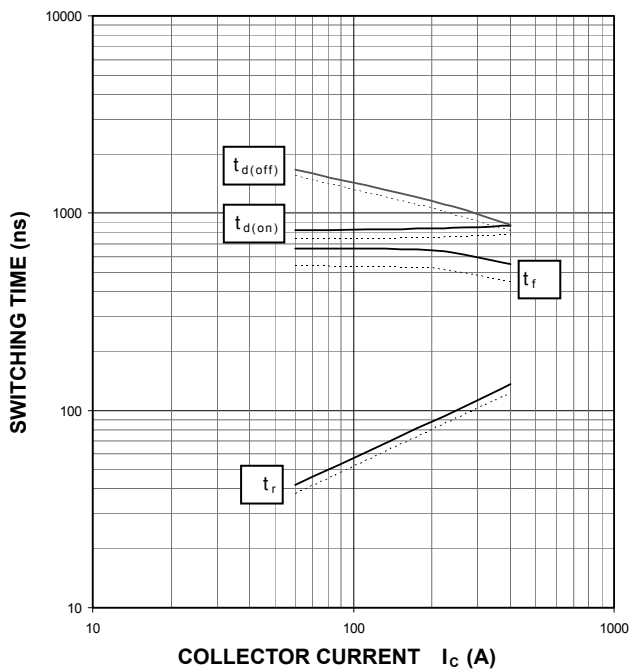

HALF-BRIDGE  
 SWITCHING CHARACTERISTICS  
 (TYPICAL)

$V_{CC}=1000\text{ V}$ ,  $V_{GE}=\pm 15\text{ V}$ ,  $I_C=600\text{ A}$ , INDUCTIVE LOAD  
 —:  $T_j=150\text{ }^\circ\text{C}$ , - - - -:  $T_j=125\text{ }^\circ\text{C}$

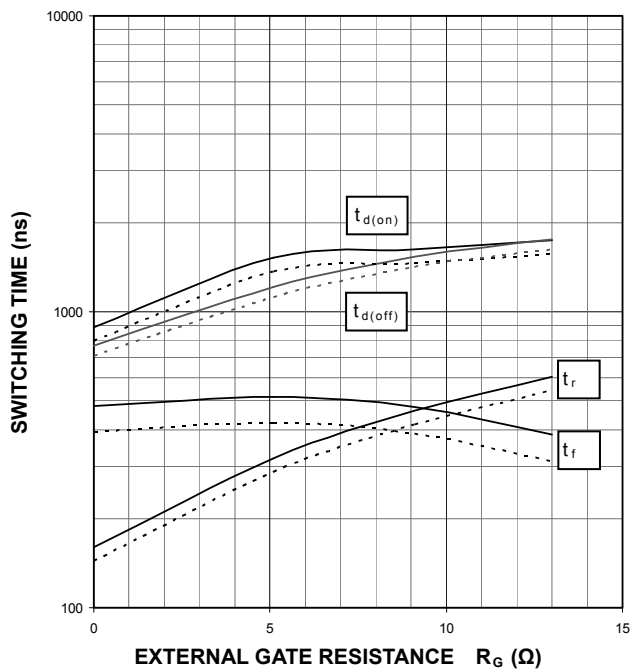

HALF-BRIDGE  
 SWITCHING CHARACTERISTICS  
 (TYPICAL)

$V_{CC}=1000\text{ V}$ ,  $V_{GE}=\pm 15\text{ V}$ ,  $R_G=0\ \Omega$ ,  
 INDUCTIVE LOAD, PER PULSE  
 —:  $T_j=150\text{ }^\circ\text{C}$ , - - - -:  $T_j=125\text{ }^\circ\text{C}$

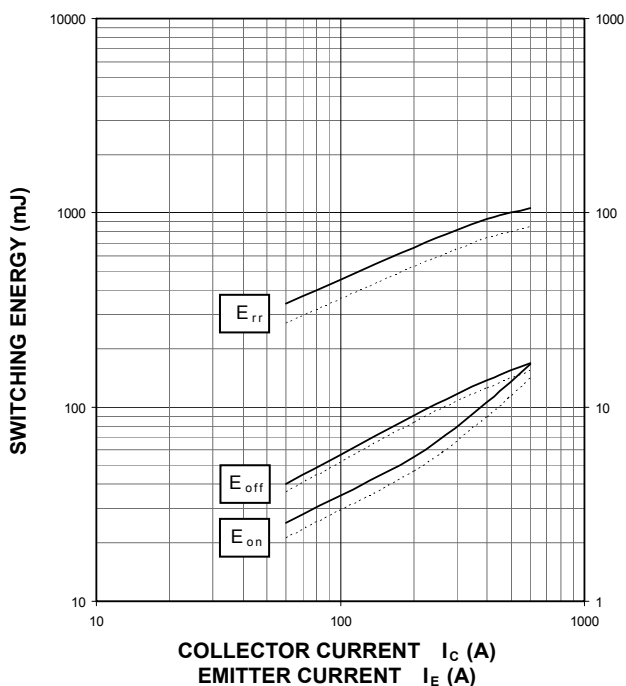

HALF-BRIDGE  
 SWITCHING CHARACTERISTICS  
 (TYPICAL)

$V_{CC}=1000\text{ V}$ ,  $V_{GE}=\pm 15\text{ V}$ ,  $I_C=600\text{ A}$ ,  
 INDUCTIVE LOAD, PER PULSE  
 —:  $T_j=150\text{ }^\circ\text{C}$ , - - - -:  $T_j=125\text{ }^\circ\text{C}$

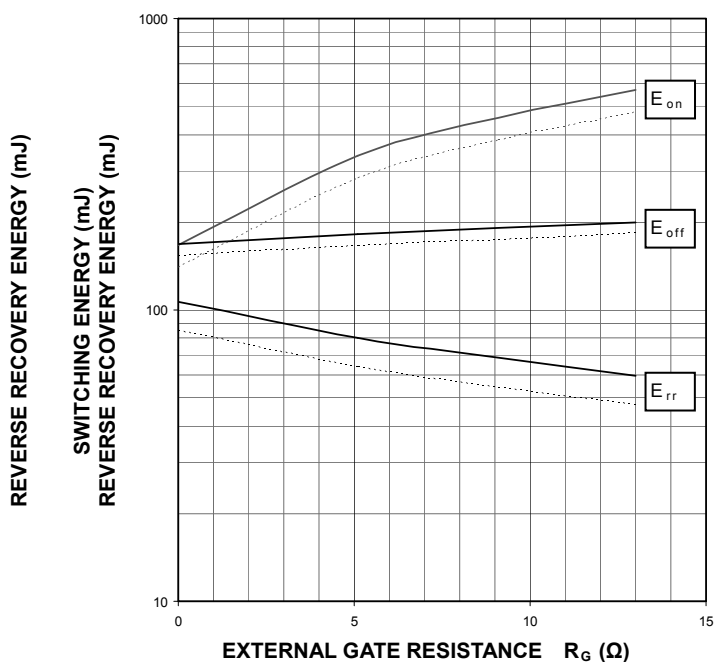

< IGBT MODULES >  
**CM600DXL-34SA**  
 HIGH POWER SWITCHING USE  
 INSULATED TYPE

**PERFORMANCE CURVES**

**INVERTER PART**

**CAPACITANCE CHARACTERISTICS**  
 (TYPICAL)

G-E short-circuited,  $T_j=25\text{ }^\circ\text{C}$

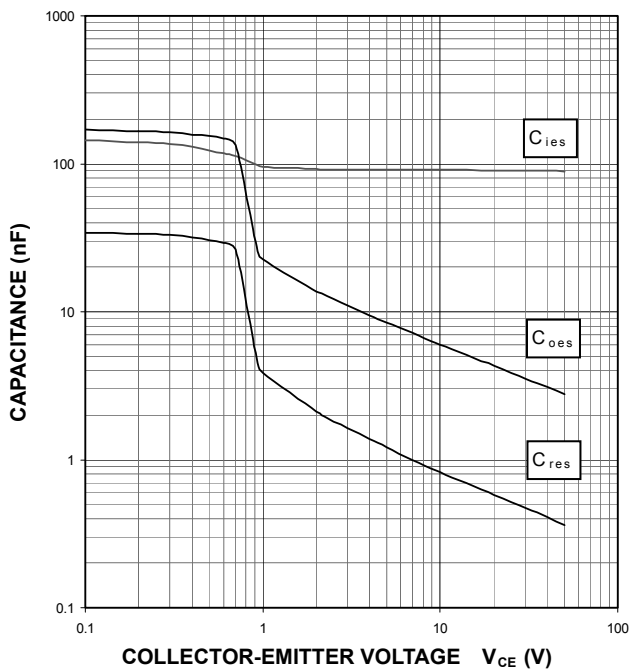

**FREE WHEELING DIODE**  
**REVERSE RECOVERY CHARACTERISTICS**  
 (TYPICAL)

$V_{CC}=1000\text{ V}$ ,  $V_{GE}=\pm 15\text{ V}$ ,  $R_G=0\ \Omega$ , INDUCTIVE LOAD  
 —:  $T_j=150\text{ }^\circ\text{C}$ , - - - -:  $T_j=125\text{ }^\circ\text{C}$

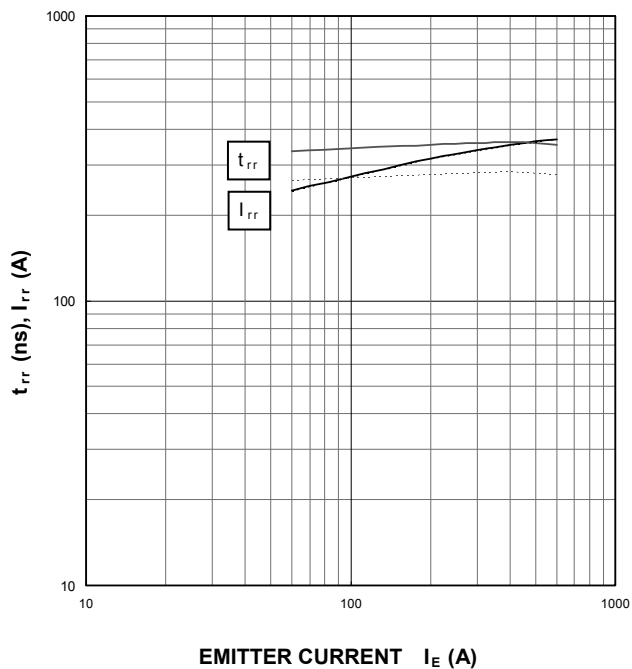

**GATE CHARGE CHARACTERISTICS**  
 (TYPICAL)

$V_{CC}=1000\text{ V}$ ,  $I_C=600\text{ A}$ ,  $T_j=25\text{ }^\circ\text{C}$

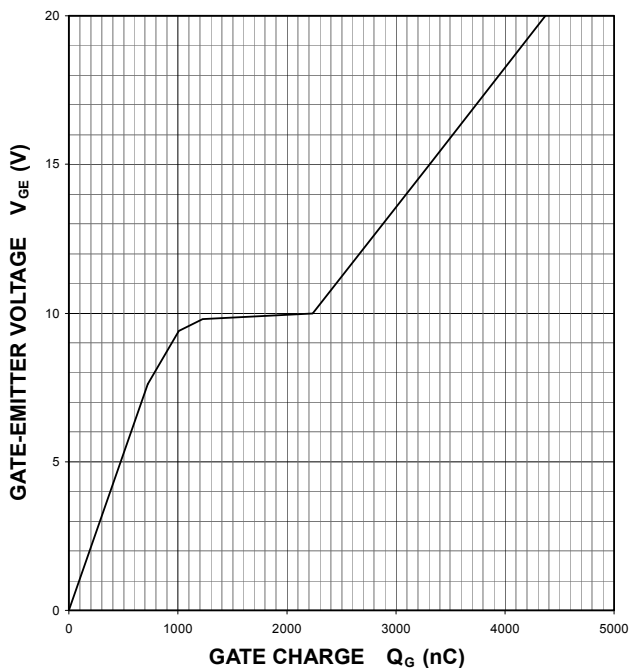

**TRANSIENT THERMAL IMPEDANCE CHARACTERISTICS**  
 (MAXIMUM)

Single pulse,  $T_C=25\text{ }^\circ\text{C}$   
 $R_{th(j-c)Q}=26\text{ K/kW}$ ,  $R_{th(j-c)D}=39\text{ K/kW}$

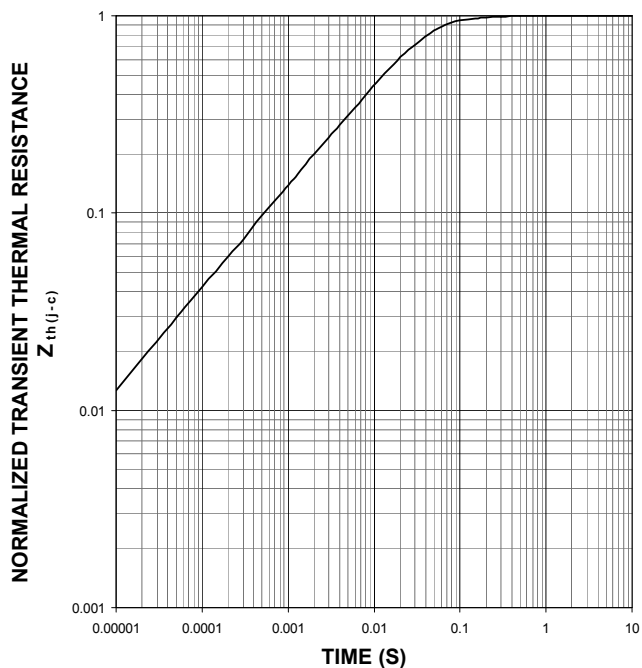



< IGBT MODULES >  
CM600DXL-34SA  
HIGH POWER SWITCHING USE  
INSULATED TYPE

---

PERFORMANCE CURVES

NTC thermistor part

TEMPERATURE CHARACTERISTICS  
(TYPICAL)

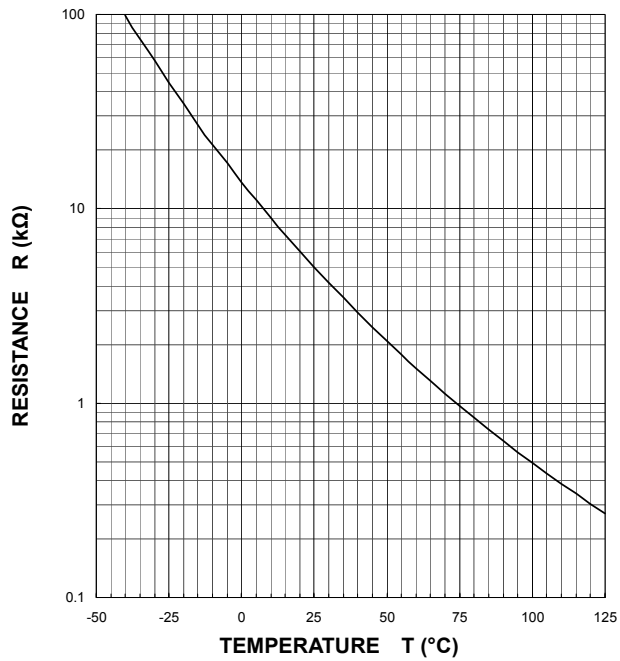

### **Keep safety first in your circuit designs!**

Mitsubishi Electric Corporation puts the maximum effort into making semiconductor products better and more reliable, but there is always the possibility that trouble may occur with them. Trouble with semiconductors may lead to personal injury, fire or property damage. Remember to give due consideration to safety when making your circuit designs, with appropriate measures such as (i) placement of substitutive, auxiliary circuits, (ii) use of non-flammable material or (iii) prevention against any malfunction or mishap.

### **Notes regarding these materials**

- These materials are intended as a reference to assist our customers in the selection of the Mitsubishi semiconductor product best suited to the customer's application; they do not convey any license under any intellectual property rights, or any other rights, belonging to Mitsubishi Electric Corporation or a third party.
- Mitsubishi Electric Corporation assumes no responsibility for any damage, or infringement of any third-party's rights, originating in the use of any product data, diagrams, charts, programs, algorithms, or circuit application examples contained in these materials.
- All information contained in these materials, including product data, diagrams, charts, programs and algorithms represents information on products at the time of publication of these materials, and are subject to change by Mitsubishi Electric Corporation without notice due to product improvements or other reasons. It is therefore recommended that customers contact Mitsubishi Electric Corporation or an authorized Mitsubishi Semiconductor product distributor for the latest product information before purchasing a product listed herein.  
The information described here may contain technical inaccuracies or typographical errors. Mitsubishi Electric Corporation assumes no responsibility for any damage, liability, or other loss rising from these inaccuracies or errors.  
Please also pay attention to information published by Mitsubishi Electric Corporation by various means, including the Mitsubishi Semiconductor home page ([www.MitsubishiElectric.com/semiconductors/](http://www.MitsubishiElectric.com/semiconductors/)).
- When using any or all of the information contained in these materials, including product data, diagrams, charts, programs, and algorithms, please be sure to evaluate all information as a total system before making a final decision on the applicability of the information and products. Mitsubishi Electric Corporation assumes no responsibility for any damage, liability or other loss resulting from the information contained herein.
- Mitsubishi Electric Corporation semiconductors are not designed or manufactured for use in a device or system that is used under circumstances in which human life is potentially at stake. Please contact Mitsubishi Electric Corporation or an authorized Mitsubishi Semiconductor product distributor when considering the use of a product contained herein for any specific purposes, such as apparatus or systems for transportation, vehicular, medical, aerospace, nuclear, or undersea repeater use.
- The prior written approval of Mitsubishi Electric Corporation is necessary to reprint or reproduce in whole or in part these materials.
- If these products or technologies are subject to the Japanese export control restrictions, they must be exported under a license from the Japanese government and cannot be imported into a country other than the approved destination.  
Any diversion or reexport contrary to the export control laws and regulations of Japan and/or the country of destination is prohibited.
- Please contact Mitsubishi Electric Corporation or an authorized Mitsubishi Semiconductor product distributor for further details on these materials or the products contained therein.